



200 Griffin Road, Unit 3, Portsmouth, NH 03801
Phone (603) 430-9282 Fax 436-2315

3 April 2024

Rick Chellman, Planning Board Chair
City of Portsmouth
1 Junkins Avenue
Portsmouth, NH 03801

RE: Request for Preliminary Conceptual Consultation Leading to Design Review at 361 Hanover Street, Proposed Site Development and New Structures

Dear Mr. Chellman and Planning Board Members:

On behalf of 361 Hanover Steam Factory, LLC we are pleased to submit the attached plan set for **Preliminary Conceptual Consultation and Design Review** for the above-mentioned project and request that we be placed on the agenda for your **April 18, 2024**, Planning Board Meeting. The project consists of the addition of a new structure and the renovation of the existing commercial building at 361 Hanover Street with the associated and required site improvements. The new structure is preferred to be entirely residential to add much needed housing stock in a desirable location where significant walkable amenities are in close proximity. Additionally, we believe that the neighborhood will be better served if the entire project is residential instead of having commercial uses on the first floor. We understand that other land use board approvals are therefore required, Planning Board input is important before we engage in that process.

The proposal includes a new building along Hanover Street with a 20-foot tunnel entrance from Hanover street to a central courtyard between the new building and the existing 361 Hanover Street (Portsmouth Steam Factory) building. The courtyard will provide access to the indoor parking areas at both the existing and the new building. The upper floors of the new Hanover Street building will contain 12 residential dwelling units and the Portsmouth Steam Factory Building would contain 24 dwelling units; for a total of 36 dwelling units. There would be 72 off-street parking spaces in the aggregate.

The project creates more than 20 dwelling units and 30,000 square feet of gross floor area so it must be submitted for **Preliminary Conceptual Consultation** as required under Section 2.4.2 of the Site Plan Regulations This applicant also seeks **Design Review** with the Planning Board as allowed under Section 2.4.3 of the Site Plan Regulations. The application conforms to the required density and development standards with some exceptions. The project therefore requires the filing of an application with the Zoning Board of Adjustment for those items. The development team would like feedback from the Planning Board before committing to that part of the process.

The following plans are included in our submission:

- Cover Sheet – This shows the Development Team, Legend, Site Location, and Site Zoning.
- Site Orthophoto – This plan shows the site bird’s eye view.
- Existing Conditions Plan C1 – This plan shows the existing site conditions in detail.
- Demolition Plan C2 – This plan shows proposed site demolition prior to construction.
- Site Plan C3 – This plan shows the site development layout with the associated Zoning Table and notations.
- Utility Plan C4 – this plan shows concept site utilities.
- Parking Plan C5 – This plan shows the lower-level parking layout and details the required parking calculations and stacked parking assignments.
- Architectural Plans A2.1 – A 3.1 – These plans show building elevations.

We look forward to an in-person presentation to the Planning Board and the Board’s review of this submission and feedback on the proposed design.

Sincerely,

A handwritten signature in black ink, appearing to read 'JRC', with a long horizontal flourish extending to the right.

John R. Chagnon, PE

P:\NH\5010135-Hampshire_Development\2977.01-Hanover St., Portsmouth-JRC\JN 2977\2024 Site Plan\Applications\City of Portsmouth Site Plan\Planning Board Concept and Design Review Submission Letter 4-3-24.doc

PORTSMOUTH STEAM FACTORY PROJECT

PROJECT NARRATIVE



361 HANOVER STREET, PORTSMOUTH, NH
HAMPSHIRE DEVELOPMENT CORPORATION

APRIL 4TH 2024

April 4, 2024

To: Rick Chellman, Planning Board Chair

Re: Project Narrative for Design Review – 361 Hanover Street, Portsmouth, NH

Executive Summary

The purpose of this submission for Design Review is two-fold. First, in preparing a formal application for Site Plan Review for the property located at 361 Hanover Street, we are seeking both confirmation and guidance on the proposed as-of-right land use, parking layout, and building and site design for this project. In particular, we want to confirm that the proposed building type, height, footprint, land uses, and off-street parking layout conforms with the Portsmouth Zoning Ordinance and Site Plan Review regulations. Secondly, we are seeking informal input from the Planning Board, City Staff, and the public through the public hearing process, as to whether there is general support and a shared preference for an alternative plan for the property that would allow for residential uses on the ground floor of the buildings. Additionally, if supported by the Board, we would also like to discuss the merits of seeking a Conditional Use Permit for an additional story on the Portsmouth Steam Factory Mill in exchange for the required workforce housing and community space.

Introduction

In accordance with Section 1.2 of Portsmouth's Site Plan Regulations (SPR), this density and scope of this proposed project will require Site Plan Approval. Per the regulations, the proposed project includes over 20 new residential dwelling units and construction of over 30,000 SF of gross floor area. Thus, Section 2.4.2 of the SPR requires a Preliminary Conceptual Consultation. Given the level of design and engineering involved with the preparation of a formal Site Plan, Section 2.4.3 of the SPR allows for non-binding discussions under the Design Review process. As such, we have submitted the information listed under Section 2.5.3 (1) and the general information listed under Section 2.5.4 (3) as appropriate for the Design Review process. The following is a summary of that information.

Design Approach and Site Planning

In designing the buildings and site design, the Design Team (DT) carefully reviewed the recommendations of the 2025 Master Plan, the 2015 North End Vision Plan, and the purpose and intent of the Character-Based Zoning. Within that framework, we have also sought to develop a context-sensitive building and site design that reflects the historic character of the Hill and Hanover Street neighborhood as well as the design narrative of the North End Vision Plan (see Figure 1). Additionally, we have sought to screen our off-street parking and avoid any spillover to the surrounding neighborhood by maximizing the number of off-street parking spaces within our existing and proposed buildings. Finally, we are seeking to modify and expand our existing license agreement with the City for the continued use of the abutting city-owned parcel. Importantly, we are seeking to replace the existing surface parking behind the building with landscaping and add a new brick sidewalk along our frontage facing Rock Street and Hanover Street.

PLAN PORTSMOUTH
NORTH END PRELIMINARY VISION PLAN

DESIGN NARRATIVE

The North End is envisioned over the long term to grow as a complementary extension of Portsmouth's downtown. Unlike many other areas of the City within the former Urban Renewal area, very little historical context remains. This fact, coupled with several large vacant parcels, makes this district ripe for redevelopment opportunities close to downtown. Implementation of this vision will likely require a wide array of innovative land use regulations, policies and programs.

The North End Vision Plan has four main components:

CIVIC SPACE

The Plan incorporates an extensive network of parks, plazas, paths, playgrounds, trails and open space. One essential feature is the waterfront trail network along the periphery of the North Mill Pond. With several landscaped fingers, this network is designed to pull the waterfront back into the North End and provide public access to and along the waterfront. In celebrating the unique history of this area, a central civic space is located adjacent to the former shipbuilding and launch ramp as a series of landscaped plazas, greens and waterfront esplanades for active and passive recreation. Across the Maplewood Avenue bridge, the existing City-owned boat launch site on Marsh Lane is expanded into a new park. The trail network also includes a path through the Union & North Cemeteries.

BUILDING DESIGN

The massing strategy of the vision plan is to respond to the surrounding context and neighborhoods by stepping down building heights and densities towards the waterfront and existing historic structures. While Portsmouth's downtown is rich in historical architectural styles, public opinion during the charrette expressed a desire for a mixture of contemporary building design, styles types, materials and a wide variety of building height, volumes and massing techniques in the North End. This purposeful distinction will help to define the North End as a unique entity while complementing and contrasting with the historic character of the larger downtown.

LAND USE

Land uses in the North End will include a variety of residential, office and commercial spaces. The Vision Plan anticipates a range of mixed-use building types from smaller rowhouses and live-work units to mid-rise buildings. Ground floor uses will be commercial in order to activate streetscapes and to keep residences out of potential flood zones. Ideally, these residential units will incorporate a full range of housing opportunities from affordable workforce housing to luxury units. Parking will be located in the rear of lots, in subterranean garages or in wrapped parking structures to be concealed from public view. There may be an opportunity to support mill housing on the former PSNH Substation parcel now that much of the equipment has been removed or consolidated. Additionally, the plan envisions the eventual removal of the overhead transmission lines.

TRANSPORTATION & INFRASTRUCTURE

The Vision Plan anticipates a harmonious integration of various modes of transportation including pedestrian, bicycle, vehicular and transit connections in the form of bus and future passenger rail lines. All thoroughfares are designed to be pedestrian-friendly and incorporate multi-modal design features including generous sidewalks and bike lanes where possible. The City is planning to replace the Maplewood Avenue bridge over the North Mill Pond. When this is done, there may be opportunities to integrate new buildings and waterfront dining to better connect the Dennett Street area with the North End.

© 2014 Town Planning & Urban Design Collaborative LLC



- 1 NOBLE'S ISLAND
- 2 ALBACORE MUSEUM
- 3 PSNH SUBSTATION
- 4 MAPLEWOOD/DENNETT GATEWAY REDEVELOPMENT
- 5 MARSH LANE PARK
- 6 WATERFRONT DINING
- 7 MILL POND CIVIC PLAZA & GREEN
- 8 MILL POND WATERFRONT PARK & GREENWAY
- 9 35 ARTSPACE
- 10 MARKET STREET ROUNDABOUT & PARKS
- 11 NORTH END PLAZA
- 12 FUTURE HARBORCOP/WHOLE FOODS CONVENTION CENTER
- 13 UNION CEMETERY/NORTH CEMETERY
- 14 MAPLEWOOD HISTORIC HOMES
- 15 TRANSIT ORIENTED DEVELOPMENT
- 16 FUTURE PASSENGER RAIL STATION
- 17 FUTURE NORTH END PARKING GARAGE W/ MIXED-USE LINER BUILDING
- 18 FUTURE MAPLEWOOD PARKING GARAGE W/ MIXED-USE LINER BUILDING
- 19 FUTURE MAPLEWOOD AVENUE SQUARE/PARK
- 20 FUTURE ARTISAN/WORKFORCE HOUSING DISTRICT
- 21 FUTURE UPWARD EXTENSION OF HEINEMANN BUILDING
- 22 FUTURE MIXED-USE DISTRICT
- 23 FUTURE INFILL & LINER BUILDINGS

Figure 1 – North End Vision Plan

Neighborhood Context

The surrounding neighborhood context is characterized by a mix of land uses, building heights and footprints. The context includes the 14 properties shown on Figure 2. The context includes a portion of Foundry Place as well as Hanover, Hill, Rock, and Sudbury Streets. As shown in Figure 2, to the west of the property, most existing structures are 2 to 2 ½ stories, of wood-frame construction and are built in the late 18th and 19th century. These smaller historic structures are also located directly along the street edge with narrow side yards on small urban lots with limited off-street parking.

To the north are considerably larger urban structures associated with the recent development within the North End Incentive Overlay District. Most buildings on the north side are 4-5 stories and 52-64 feet in height with large footprints, high building coverage, and limited active commercial uses on the ground-floor. Parking is primarily located on the ground-floor behind a commercial liner building. Importantly, the 6 level (64') Foundry Place municipal parking structure, shown on Figure 2, is located direct behind 361 Hanover Street.

To the south, the existing land use pattern is represented by larger, multi-family structures built in the late 19th century. Additionally, the Pearl Church is located directly across the site and it is a two-story, wood frame building that is 40 in height and currently used as a mixed-use space.

To the east, the land use pattern is characterized with two – to three-story wood frame multi-family historic structures. These structures were built in the mid-19th century, have high building coverage, and have limited open space due to parking behind and between the structures.

NEIGHBORHOOD CONTEXT MAP – 361 HANOVER STREET, PORTSMOUTH, NH



Figure 2 – Neighborhood Context Map

Figure 3 shows an aerial view of the surrounding context and illustrates the substantial footprint of the former industrial building as well as the recent suburban surface parking lots along Hanover Street and at the end of Hill Street.



Figure 3 – Existing Context – Aerial View of 361 Hanover Street

Site Plan Review Application Required Information

The following information has been submitted for review and consultation during the Design Review process.

Site Plan Review Checklist

The Site Plan specifications, required exhibits, and supporting documentation have been provided and posted on the city’s online permitting system (OpenGov). The following plans, elevations and exhibits have been submitted for review and consultation:

**City of Portsmouth, New Hampshire
Site Plan Application Checklist**

This site plan application checklist is a tool designed to make the applicant in the process easier and for speeding the application to drawing board review. The checklist is required to be completed and submitted to the City's online permitting system. It is not a substitute for the applicant's professional expertise. It is strongly encouraged to submit project information for review and consultation during the design review process. This document is intended for use as a guide and is not intended to be a substitute for the applicant's professional expertise.

Applicant Responsibility (Section 2.2.1): Applicant has the duty to provide all required information. The applicant shall be responsible for providing and providing information for the review of the application. The applicant shall be responsible for providing and providing information for the review of the application.

Name of Applicant: _____ Date Submitted: _____
 Applicant # (in City's online permitting): _____ Map: _____ Lot: _____
 Site Address: _____

Application Requirements		
Required items for Submission	Item Location (e.g. Page or Plan Sheet/Note #)	Waiver Requested
<input checked="" type="checkbox"/> Complete application form submitted via the City's web-based permitting program (4.2.112.5-2.34)		N/A
<input checked="" type="checkbox"/> All application documents, plans, supporting documentation and other materials uploaded to the application form in viewable digital Portable Document Format (PDF). One hard copy of all plans and drawings shall be submitted to the Planning Department by the published deadline. (2.2.2.1)		N/A

Site Plan Review Application Required Information		
Required items for Submission	Item Location (e.g. Page/line or Plan Sheet/Note #)	Waiver Requested
<input checked="" type="checkbox"/> Statement that lists and describes "green" building components and systems. (2.2.3.1)		N/A
<input checked="" type="checkbox"/> Existing and proposed gross floor area and dimensions of all buildings and statement of uses and floor area for each floor. (2.2.3.1c)		N/A
<input checked="" type="checkbox"/> The map and lot number, and current zoning of all parcels under Site Plan Review. (2.2.3.10)		N/A

Site Plan Application Checklist, December 2020 Page 1 of 6

1. Existing Conditions
2. Building and Structures
3. Access and Circulation
4. Parking and Loading
5. Utilities
6. Solid Waste Facilities
7. Storm Water Management
8. Landscaping & Open Space
9. Easement and License Plans
10. Character District Data

Historic Use – the Portsmouth Steam Factory

As shown in Figure 4, the historic structure on the property is the remaining first and second floor of the former five- story Portsmouth Steam Factory (c. 1840). Additionally, a portion of the former

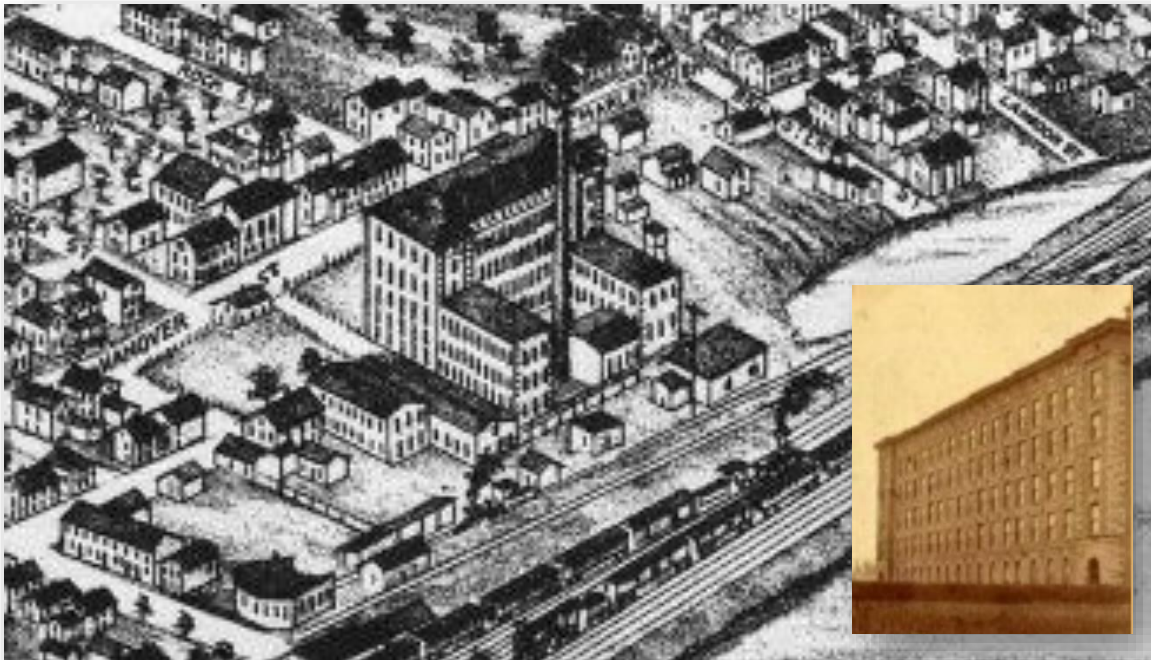

Figure 4 – Former Portsmouth Steam Factory (c. 1840)

Powerhouse Building (c. 1840), a single-story building, remains and is located between Hill Street and Foundry Place. The Portsmouth Steam Factory is a masonry structure designed as an Italianate Renaissance Revival-style building with symmetrical elevations. The building was significantly reduced in height as a result of a fire in the late 19th century.

Existing Zoning

Character District

As shown in Figure 5, the property is located within the CD5 Character District. The CD5 District is an urban zoning district that allows for a wide variety of higher density commercial and residential uses. Figure 6 shows the Development Standards for the CD5. Such standards allow for 95% building coverage, footprints of up to 20,000 SF and just 5% open space. For buildings located along a public street a maximum setback of 5 feet is required. Flat, Gable, Mansard, Gambrel, and Hip roofs are all permitted in the CD5.

Overlay Districts

The northern half of the property is also located within the North End Incentive Overlay District (NEIOD). The entire property is also located within the Downtown Overlay District (DOD).

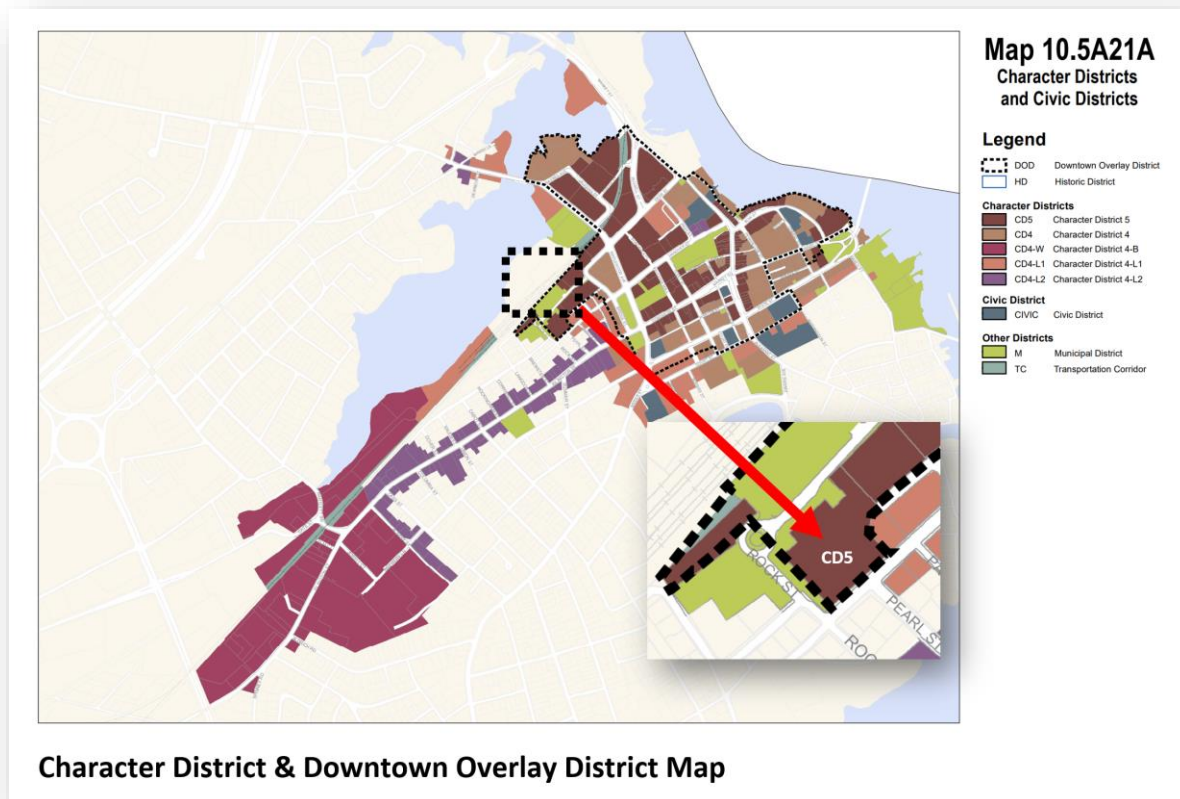
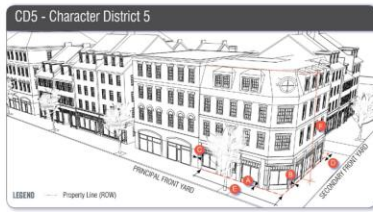

Figure 5 – Character and Overlay District Map

FIGURE 10.5A41.100 DEVELOPMENT STANDARDS
CHARACTER DISTRICT 5 (CD5)



BUILDING PLACEMENT – PRINCIPAL BUILDING*	
Maximum principal front yard	5 ft
Maximum secondary front yard	5 ft
Side yard	NR
Minimum rear yard	Greater of 5 ft from rear lot line or 10 ft from center line of alley
Minimum front lot line buildout	80%

* Except for items listed under Section 10.5A42.12

BUILDING AND LOT OCCUPATION	
Maximum building block length	225 ft
Maximum facade modulation length	100 ft (see Section 10.5A43.20)
Maximum entrance spacing	50 ft
Maximum building coverage	95%
Maximum building footprint	20,000 sf (or as allowed by Section 10.5A43.40)

BUILDING FORM – PRINCIPAL BUILDING	
Minimum lot area	NR
Minimum lot area per dwelling unit	NR
Minimum open space	5%
Maximum ground floor GFA per use	15,000 sf
Building height	See Map 10.5A21.B & Section 10.5A43.30
Maximum finished floor surface of ground floor above sidewalk grade	36"
Minimum ground story height	12 ft
Minimum second story height	10 ft
Facade glazing:	
Shopfront facade	70% min.
Other facade types	20% min. to 50% max.
Roof type	flat, gable, hip, gambrel, mansard
Roof pitch, if any	
Gable	6:12 min. to 12:12 max
Hip	3:12 min.
Mansard/gambrel	6:12 min. to 30:12 max.

FIGURE 10.5A41.100 DEVELOPMENT STANDARDS
CHARACTER DISTRICT 5 (CD5)

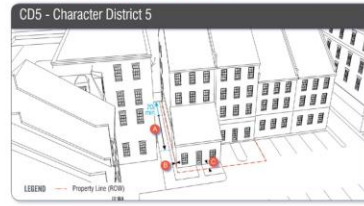

BUILDING PLACEMENT – OUTBUILDING	
Minimum front yard	20 ft behind a facade of a principal building
Minimum side yard	0 ft
Minimum rear yard	3 ft

BUILDING TYPES	
See Figure 10.5A43.60 for building type definitions	
House	not permitted
Duplex	not permitted
Rowhouse	not permitted
Apartment building	not permitted
Live/work building	permitted*
Small commercial building	permitted
Large commercial building	permitted
Cottage	not permitted
Paired House	not permitted
Gateway Townhouses	not permitted
Mixed-Use Building	permitted*
Flex Space Building	permitted
Community Building	permitted

*Residential uses are not permitted on the ground floor in the Downtown Overlay District

FACADE TYPES	
See Figure 10.5A43.10 for facade type definitions. Except where required facade types are indicated on Map 10.5A21C, the below standards apply:	
Porch	not permitted
Stoop	permitted
Step	permitted
Shopfront	permitted
Officefront	permitted
Forecourt	not permitted
Recessed-entry	permitted
Dooryard	not permitted
Terrace	not permitted
Gallery	permitted
Arcade	permitted

PARKING	
See Section 10.5A44.30	

COMMUNITY SPACE	
See Section 10.5A45	

BUILDING & LOT USE	
See Sections 10.5A30 and 10.440	

Development Standards – CD5

Figure 6 – CD5 Development Standards

The DOD requires the ground-floor use to be non-residential and all residential uses are required to be located above the ground-floor. Off-street parking is also not required for all commercial uses and a four-space parking credit is applied to any off-street parking required for either a residential or hotel use of the property.

The NEIOD allows, by a Conditional Use Permit (CUP), for an additional story, or 10 feet, of building height provided line workforce housing and community space is provided. In order to approve a CUP for the project, at least 20% of the total residential units are deed restricted to incomes at or less than 100% of Average Median Income (AMI) for a 4-person household and sold as workforce housing units or, 10% of the total residential units in a project are deed restricted to incomes at or below 60% AMI for a 3-person household and rented as workforce housing units. The workforce housing units are required to be at least 600 SF in area. Additionally, at least 10% of the property shall be deed restricted as Community Space (CS). Permitted CS types include, but are not limited to, pocket parks, pedestrian alley, wide pedestrian sidewalks, pedestrian passage, pedestrian arcade, or a shared multi-model way. Such CS shall connect to existing public sidewalks and shall include landscaping and pedestrian amenities such as benches, lighting, and other street furniture.

Building Height Standards

As shown in Figure 7, the entire property is located within the 2-3 story building height district with a maximum building height of 40 feet. Except for the existing surface parking lot along Hanover Street, the Building Height Standards Map also shows the property is located within the NEIOD.

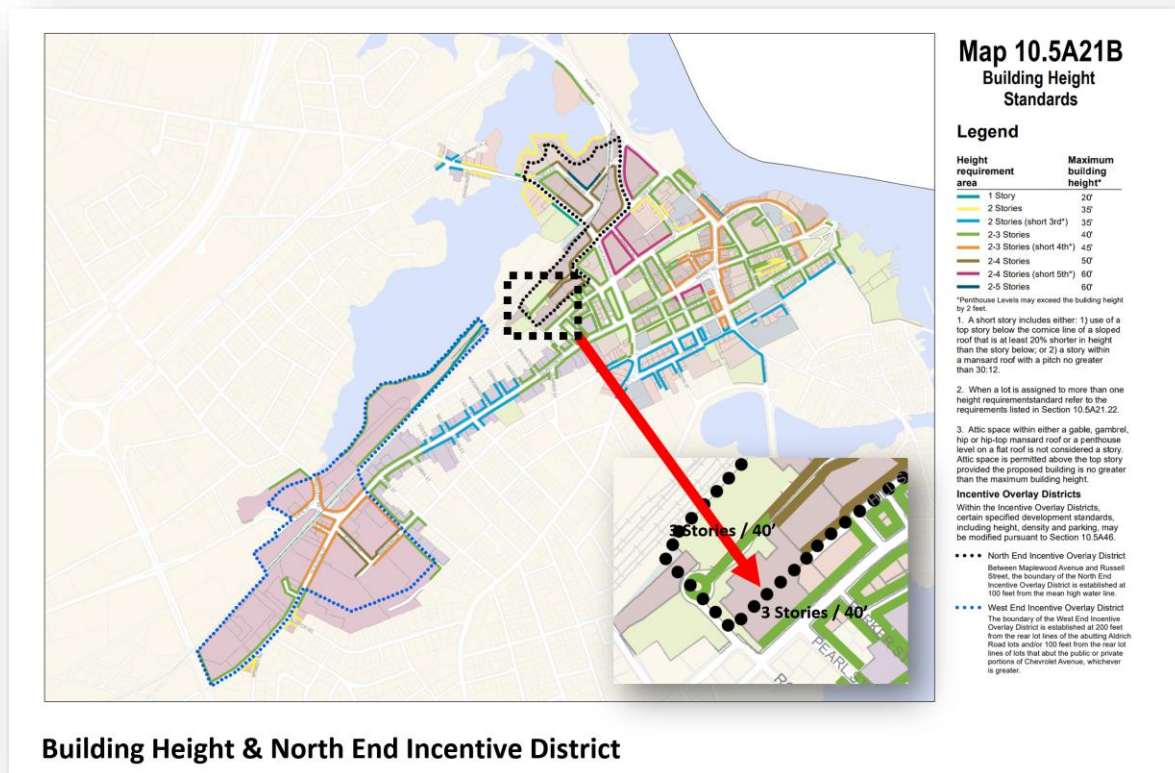

Figure 7 – Building Height Standards and Incentive Overlay District Map

Existing Conditions

As shown on Figure 8, the Existing Conditions Plans shows the two-story former Steam Factory Building with a footprint of 14,808 SF. It has a second, mezzanine level. The former Powerhouse Building has a footprint of 1,400 SF and is a single-story structure with a partial basement. The total building coverage on the lot is 32%. Both buildings are currently used commercially as professional office and light industrial uses. There are 61 off-street surface parking spaces on the property. Vehicular access to the parking lot is limited to Hanover Street, a Public Street. Private access to the property is also provided from Hill Street, a private way. An access easement is also provided across the Hanover Street parking area to the abutting lot (349 Hanover Street).

The property also has access to the rear parking area adjacent Foundry Place through a license agreement with the City to the 23,000 SF property along Foundry Place. Notably, the retaining walls separating this rear parking area and Foundry Place are between 5 and 8 feet in height. The property has virtually no open space, is 97.5% impervious, and has limited landscaping.

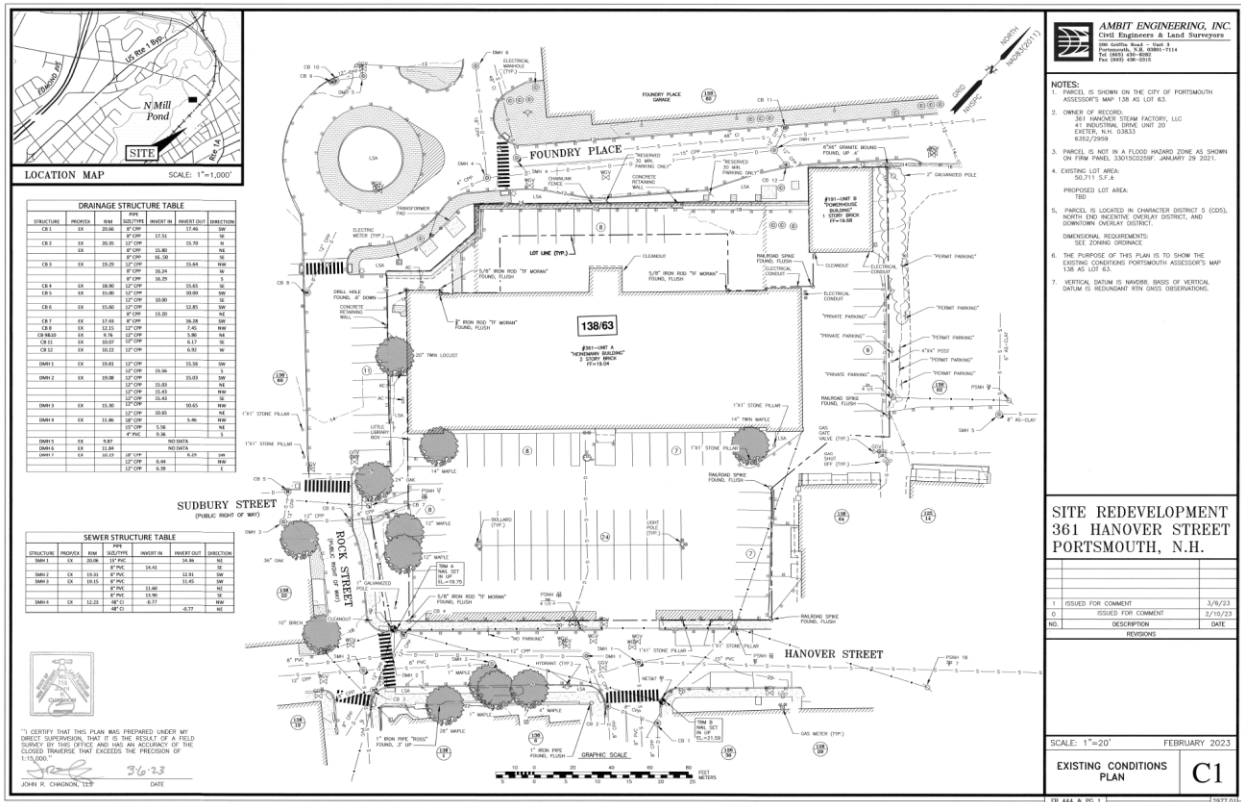

Figure 8 - Existing Conditions (includes the former Powerhouse Building)

Buildings and Structures

Figure 9 shows the existing buildings and parking areas on the property. Area A is the remaining first and second floor of the former Portsmouth Steam Factory, Area B is the former Powerhouse Building, and Area C is the existing surface parking lot along Hanover Street.





Figure 9 - Existing Conditions showing Buildings and Parking Areas

Proposed Subdivision Plan

As part of the proposed reorganization of the ownership structure for the property, we are seeking to subdivide the property into two lots. As shown in Figure 10, Lot 1 will contain the former Powerhouse Building, currently *The Last Chance Garage*. Lot 1 is proposed to be a conforming lot with 4,717 SF of land area with 8 off-street parking spaces. Lot 1 will also have an access easement across Lot 2 to Hanover Street. Lot 2 will contain the former Portsmouth Steam Factory building – currently the Portsmouth Offices for the Hampshire Development Corporation – and be 38,528 SF in land area and have frontage and access off of Hanover Street and have 53 surface parking spaces along Hanover Street.



Figure 12 – Proposed Elevations for the Portsmouth Steam Factory Building

Both buildings show an attic level under a mansard roof. The Portsmouth Steam Factory building has a total GFA of nearly 75,000 SF with up to 42 parking spaces proposed within the ground story of the building. Figure 12 shows the proposed three-story mansard building along Hanover Street. The Hanover Street building has ground floor commercial uses along the street edge within a liner building and 26 off-street parking spaces within the rear portion of the ground floor. Additionally, there are four visitor spaces proposed for the courtyard area between the buildings.



Figure 13 – Proposed Elevations for the Mixed-Use Hanover Street Building

Figure 14 shows a cross section of the Hanover Street building and a proposed building height of 40 feet. Importantly, both buildings are proposed to meet the requirement to be no taller than 3 stories (plus and attic level within a mansard roof) and 40 feet. Both buildings will also be designed using traditional design principles to fit in with their surrounding historic context.

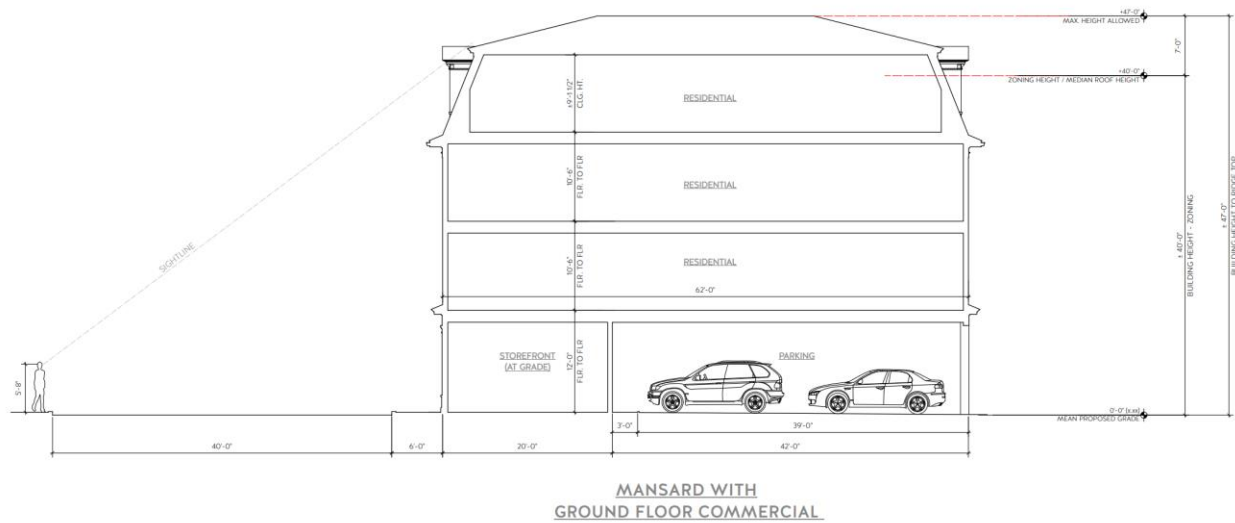

Figure 14 – Proposed Building Height for the Mixed-Use Hanover Street Building

Figure 15 shows the proposed 3 story building in context along Hanover Street.



Figure 15 – Proposed Rendering of Hanover Street Mixed-Use Building

Proposed Building Dimensions and Land Use

Table 1 lists the proposed uses and gross floor areas by floor for the existing and proposed building.

EXISTING PORTSMOUTH STEAM FACTORY MILL BUILDING					
Floor	Primary Use	GFA (SF)	Accessory Use	GFA (SF)	Total GFA (SF)
1	Commercial	3,264	Parking	15,516	18,780
2	Residential	18,780	-	-	18,780
3	Residential	18,780	-	-	18,780
Attic	Residential	17,800	-	-	17,800
		58,624		15,516	74,140
PROPOSED HANOVER STREET BUILDING					
Floor	Primary Use	GFA (SF)	Accessory Use	GFA (SF)	Total GFA (SF)
1	Commercial	2,816	Parking	6,856	9,672
2	Residential	10,912	-	-	10,912
3	Residential	10,912	-	-	10,912
Attic	Residential	10,300	-	-	10,300
		34,940		6,856	41,796

Table 1 – Uses and Gross Floor Area of the Proposed Buildings

Future Studies

As we prepare for a formal SPR submission, we are seeking guidance on whether the Board would like traffic study for the project.

Green Building Statement

The proposed building is still in design development but may be designed with solar-ready roof systems and use hi-efficiency heat pumps for heating and cooling. Additional information will be provided for the formal site plan submission.

License Plan

As shown on Figure 17, the project includes a modified license amendment with the city to improve and maintain the land area, highlighted in blue, owned by the city along Foundry Place and Rock Street. Except for the area at the intersection of Rock and Hanover Streets, most of this city-owned property is inaccessible due to the presence of an 5-10 foot retaining wall along Foundry Place and a four-foot retaining wall and steep grades along Rock Street between Sudbury Street and Foundry Place. As shown on the proposed site plan, a 6-foot-wide brick sidewalk is proposed to be constructed along the property lines fronting on Hanover and Rock Street to Sudbury Street.

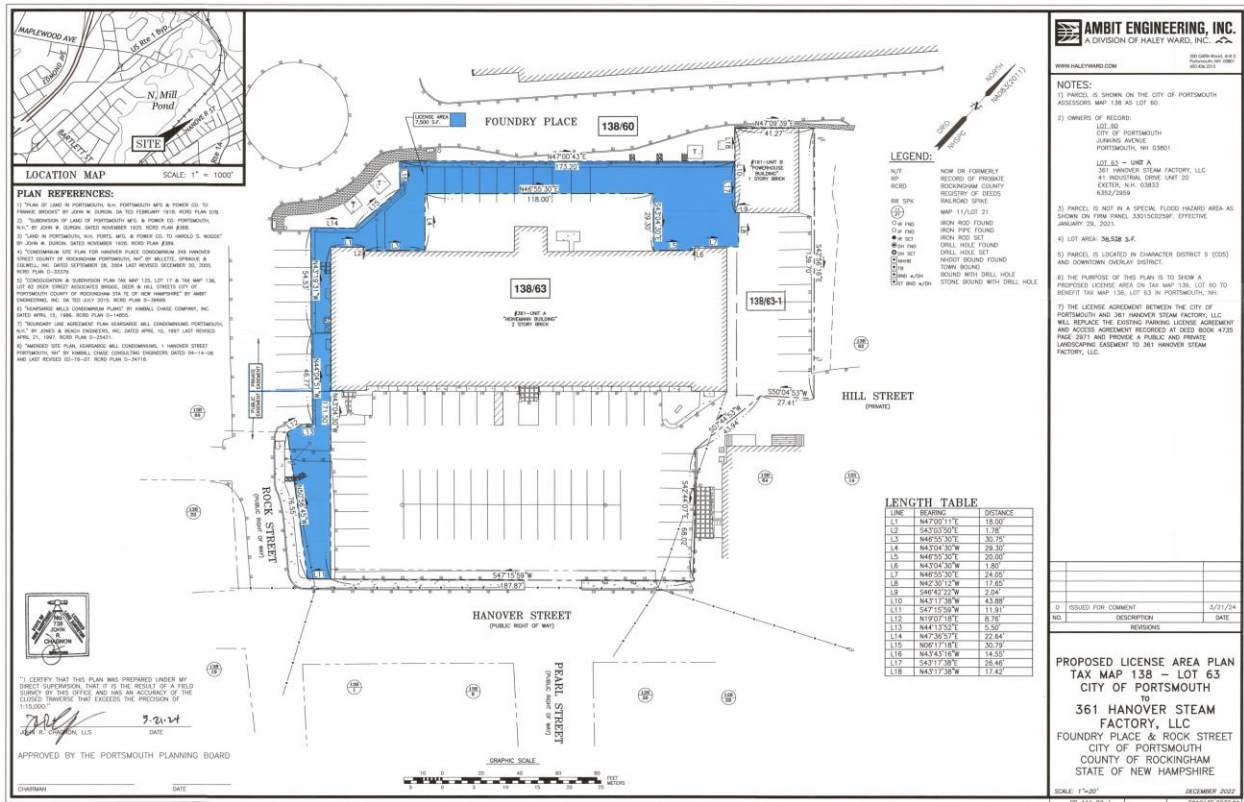

Figure 17 – Proposed License Agreement Plan with the City

Access and Circulation

As shown above in the proposed site plan, access and egress to the site is proposed using a 20-foot driveway connecting Hanover Street to the proposed courtyard between the buildings. The courtyard will provide access to structured parking within the two buildings as well as four visitor spaces within the courtyard. All parking spaces and driveway aisles will conform to the required minimum dimensions. Emergency access will be provided using the proposed tunnel and driveway within the courtyard area.

Parking and Loading

As shown in Figure 18, there are 72 proposed off-street parking spaces shown on the proposed site plan. Given the property is located within the DOD only 51 spaces are required for the proposed use. A total of 47 spaces are required for 36 dwelling units given the units are all over 750 SF in GFA. Additionally, 8 visitor spaces are required for a total of 55 spaces. Tandem parking spaces will be assigned to the same unit owner. The DOD does not require any off-street parking for any proposed commercial uses and there is a four-space credit from the required parking. Thus, in the aggregate, the proposed building design and site plan has the capacity to provide nearly 2 spaces per dwelling unit plus visitor parking thereby minimizing any potential spillover parking to the abutting neighborhood.

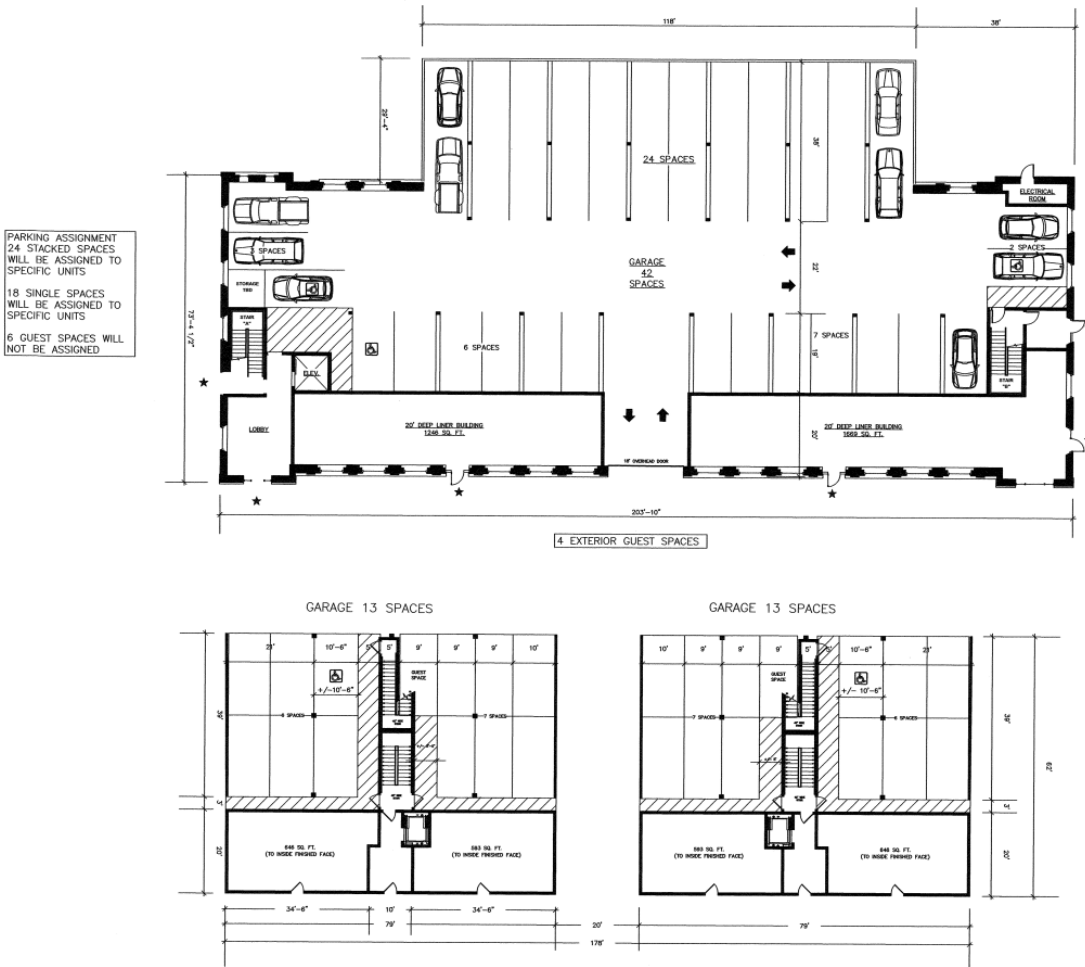

Figure 18 – Proposed Parking Layout (72 Spaces)

Water and Sewer Infrastructure

The proposed buildings will be connected to the city’s water distribution and sewer collection systems.

Utilities

The proposed buildings will be served by Eversource. Generators will likely be located on the roof structures and all HVAC units will either be internal or roof mounted units.

Solid Waste

All solid waste will be managed inside the buildings using totes and a solid waste room.

Stormwater Management

The site is currently 98% impervious. A stormwater management plan will be prepared for formal Site Plan submission. Snow will be removed from the site and a management plan will be prepared.

Outdoor Lighting

A lighting plan will be proposed for the site. All on-site lighting will be energy efficient and use dark-sky compliant lighting.

Landscaping

A detailed landscape plan will be developed for the courtyard area and, pending approval by the city, a detailed landscape improvement plan will be submitted for the city-owned license area.

Open Space

The site will show the required 5% open space areas with at least 51% as pervious surfaces.

Easements and Licenses

A detailed easement plan will be developed showing all access easements and license areas.

Character District Zoning

The two proposed mixed-use buildings meet all the development standards of the CD5. Table 2 illustrates how the two buildings comply.

ZONING DEVELOPMENT STANDARD			
CD5: CHARACTER DISTRICT 5, DOD: DOWNTOWN OVERLAY DISTRICT			
	REQUIRED	EXISTING	PROPOSED
Height	2-3 stories 40'	2 stories / 18" +/-	3 stories / 40'
Penthouses	may exceed bldg height by 2'	NA	NA
Roof appurtenance	may exceed bldg height by 10'	< 10'	<10'
Façade Types		NA	NA
Building Types	commercial, live-work, mixed use, flex space & community.	Commercial	Mixed-Use
Front (principle) max	5	99'	1'
Front (secondary) max	5	0'	0'
Side	NR	0.00	1'
Rear yard	5'	0'	0'
Front lot line buildout	80% min	100%	94%
Lot area (sf)	NR	N/A	N/A
Lot area per dwelling	NR	N/A	N/A
Building coverage, maximum	95%	34.0%	75.0%
Maximum building footprint	20,000	14,808	18,808
Ground floor area per use, max	15,000	18,808	7,660
Open space, minimum	5%	<5%	5.3%
Permitted uses		Commercial	Mixed-Use
Block length, max (ft)	225	205'	178'
Façade modulation length, max (ft)	100	205'	79'
Entrance spacing, max (ft)	50	>50'	<50'
Floor height above sidewalk, max	36"	0'	0'
Ground story height, min	12'	10'	12'
Second story height, min	10'	10'	10'
Glazing, shopfront, min	70%	NA	NA
Glazing, other	20%-50%	>20%	>20%
Roof types	flat, gable, hip, gambrel, mansard	Flat	Mansard

Table 2 – Zoning Development Standards for As-of-Right Plan

Alternative Plans

Ground-Floor Residential Uses

As part of the informal discussion during the Design Review process, we would like to also discuss the merits of two alternative plans. The first, (shown in Figures 19 and 20) simply proposes to convert the required ground floor commercial space to residential. A variance from the Board of Adjustment would be required to make this change. However, we believe the abutters and larger neighborhood would prefer residential uses on the ground floor to reduce any adverse impacts on the neighborhood such as noise, lighting, and overflow parking. As shown in Figures 19 and 20, changing from a commercial storefront to a residential entryway simplifies the façade along Hanover Street to be more in keeping with the architectural character of the neighborhood buildings.



Figure 19 – Required Ground Floor Commercial Use in Hanover Street Building



Figure 20 – Alternative Ground Floor Residential Use in Hanover Street Building

The second alternative plan (which could also include the alternative plan to convert the ground-floor commercial space to residential) involves using the NEIOD zoning to add an additional story to the Portsmouth Steam Factory Mill Building for a total of four stories or 50' (see Figure 21). Unlike the surface parking lot along Hanover Street, the Portsmouth Steam Factory Building is located within the NEIOD. The overlay district allows the Board to approve a CUP to allow for an additional story or 10 feet to be added to the building provided both workforce housing and community space are provided. Notably, the Hanover Street building is not located within the NEIOD so is ineligible for the additional story.



1 SOUTH ELEVATION WITH FIVE STORIES (RESIDENTIAL FIRST FLOOR)
Scale: 1/8" = 1'-0"

Figure 21 – Alternative to Add an Additional Story to the Portsmouth Steam Factory Building

As shown in Figure 22, adding an additional story to the building, would allow up to 46 dwelling units to be located within the two buildings. This would result in a requirement for 60 off-street parking spaces and 8 visitor spaces to be located partially within the courtyard and within the ground-floor of the buildings.

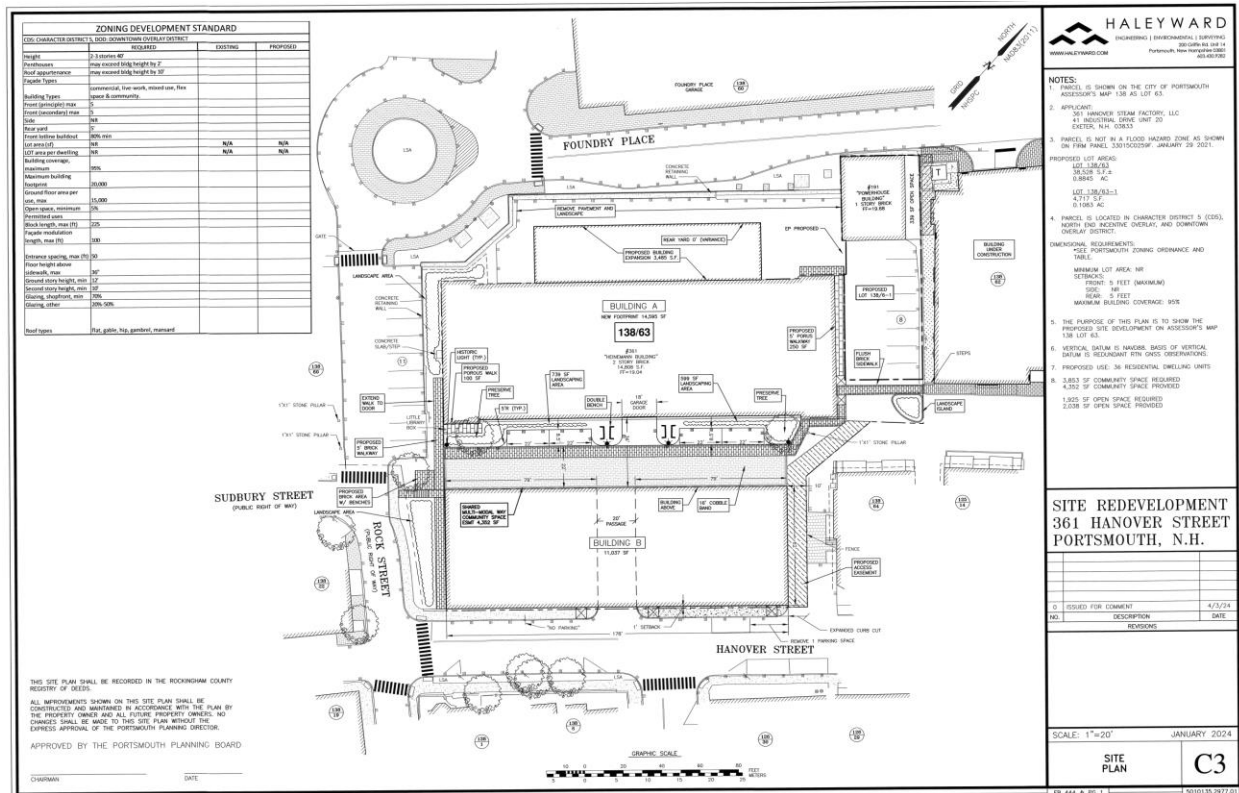

Figure 22 – Alternative Plan showing Community Space (Shared Multi-Modal Way)

As required under the CUP, at least 10% (3,853 SF +/-) of the property would be deeded as Community Space (CS). As shown on Figure 23, the proposed CS would be a 4,352 SF Shared Multi-Modal Way between the two buildings. Landscaping and a formal pedestrian connection from Rock Street through the courtyard would be provided to Hill Street.

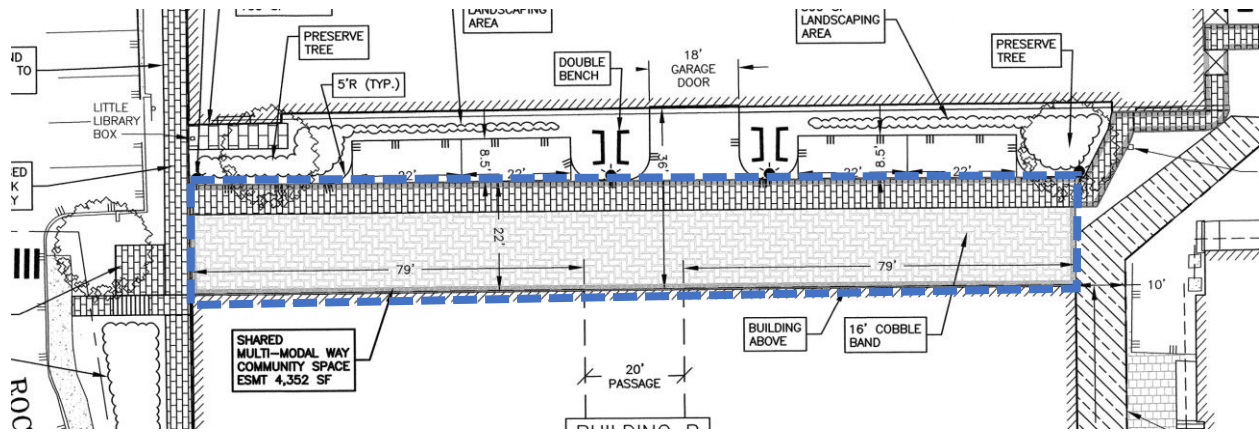

Figure 23 – Proposed Multi-Modal Way

Additionally, as required under the CUP, at least 10% of the proposed dwelling units would be deemed restricted as rental Workforce Housing Units and be rented to a household with an income of no more than 60% of the median family income for a 3-person household. Such units will be at least 600 SF in GFA and are proposed to be located within the ground-floor of both buildings.

Summary

We believe the as-of-right site plan submitted for this Design Review process fully conforms to all Zoning and Site Plan requirements without the need for waivers or variances. However, based on preliminary feedback from the neighborhood, we believe the alternative plan(s) are preferred to mitigate any potential adverse impacts of commercial uses on the ground-floor and, under the CUP plan, provide the city with needed workforce housing in the downtown area as well as community space to make a formal and permanent pedestrian link between the Rock and Sudbury Street neighborhood to Hill Street and the heart of the North End. As such, we appreciate any informal feedback the Planning Board can provide on the plan options presented in this narrative as zoning relief may be required to support the building program or development standards for the project. Similarly, your preliminary feedback on the merits of a CUP for the Portsmouth Steam Factory building will allow us to select a development option and prepare a formal application for Site Plan Review.

PROPOSED DEVELOPMENT

361 HANOVER STREET PORTSMOUTH, NEW HAMPSHIRE DESIGN REVIEW PLANS

OWNER/APPLICANT:

361 HANOVER STEAM
FACTORY, LLC
41 INDUSTRIAL DRIVE UNIT 20
EXETER, NH 03833
TEL. (603) 235-5475

CIVIL ENGINEER/LAND SURVEYOR:

AMBIT ENGINEERING, INC.
200 GRIFFIN ROAD, UNIT 3
PORTSMOUTH, N.H. 03801
TEL. (603) 430-9282

ARCHITECT:

SCOTT BROWN
29 WATER STREET, SUITE 209
NEWBURYPORT, MA 01950
TEL. (978) 465-3535

PLANNING CONSULTANT:

NICHOLAS CRACKNELL
TEL. (978) 270-4789

LAND USE ATTORNEY:

BOSEN & ASSOCIATES
266 MIDDLE STREET
PORTSMOUTH, N.H. 03801
TEL. (603) 427-5500

PERMIT LIST:
PORTSMOUTH HDC:
PORTSMOUTH ZONING BOARD:
PORTSMOUTH SITE REVIEW:
PORTSMOUTH CONDITIONAL USE PERMIT:

LEGEND:

EXISTING	PROPOSED	
---	---	PROPERTY LINE
---	---	SETBACK
S	S	SEWER PIPE
SL	SL	SEWER LATERAL
G	G	GAS LINE
D	D	STORM DRAIN
W	W	WATER LINE
WS	WS	WATER SERVICE
UGE	UGE	UNDERGROUND ELECTRIC
OHW	OHW	OVERHEAD ELECTRIC/WIRES
---	---	FOUNDATION DRAIN
---	---	EDGE OF PAVEMENT (EP)
100	100	CONTOUR
97x3	98x0	SPOT ELEVATION
○	○	UTILITY POLE
⊙	⊙	WALL MOUNTED EXTERIOR LIGHTS
⊙	⊙	TRANSFORMER ON CONCRETE PAD
⊙	⊙	ELECTRIC HANDHOLD
⊙	⊙	SHUT OFFS (WATER/GAS)
⊙	⊙	GATE VALVE
⊙	⊙	HYDRANT
⊙	⊙	HYDRANT
⊙	⊙	CATCH BASIN
⊙	⊙	SEWER MANHOLE
⊙	⊙	DRAIN MANHOLE
⊙	⊙	TELEPHONE MANHOLE
⊙	⊙	PARKING SPACE COUNT
⊙	⊙	PARKING METER
LSA	LSA	LANDSCAPED AREA
TBD	TBD	TO BE DETERMINED
CI	CI	CAST IRON PIPE
COP	COP	COPPER PIPE
DI	DI	DUCTILE IRON PIPE
PVC	PVC	POLYVINYL CHLORIDE PIPE
RCP	RCP	REINFORCED CONCRETE PIPE
AC	AC	ASBESTOS CEMENT PIPE
VC	VC	VITRIFIED CLAY PIPE
EP	EP	EDGE OF PAVEMENT
EL	EL	ELEVATION
FF	FF	FINISHED FLOOR
INV	INV	INVERT
S =	S =	SLOPE FT/FT
TBM	TBM	TEMPORARY BENCH MARK
TYP	TYP	TYPICAL

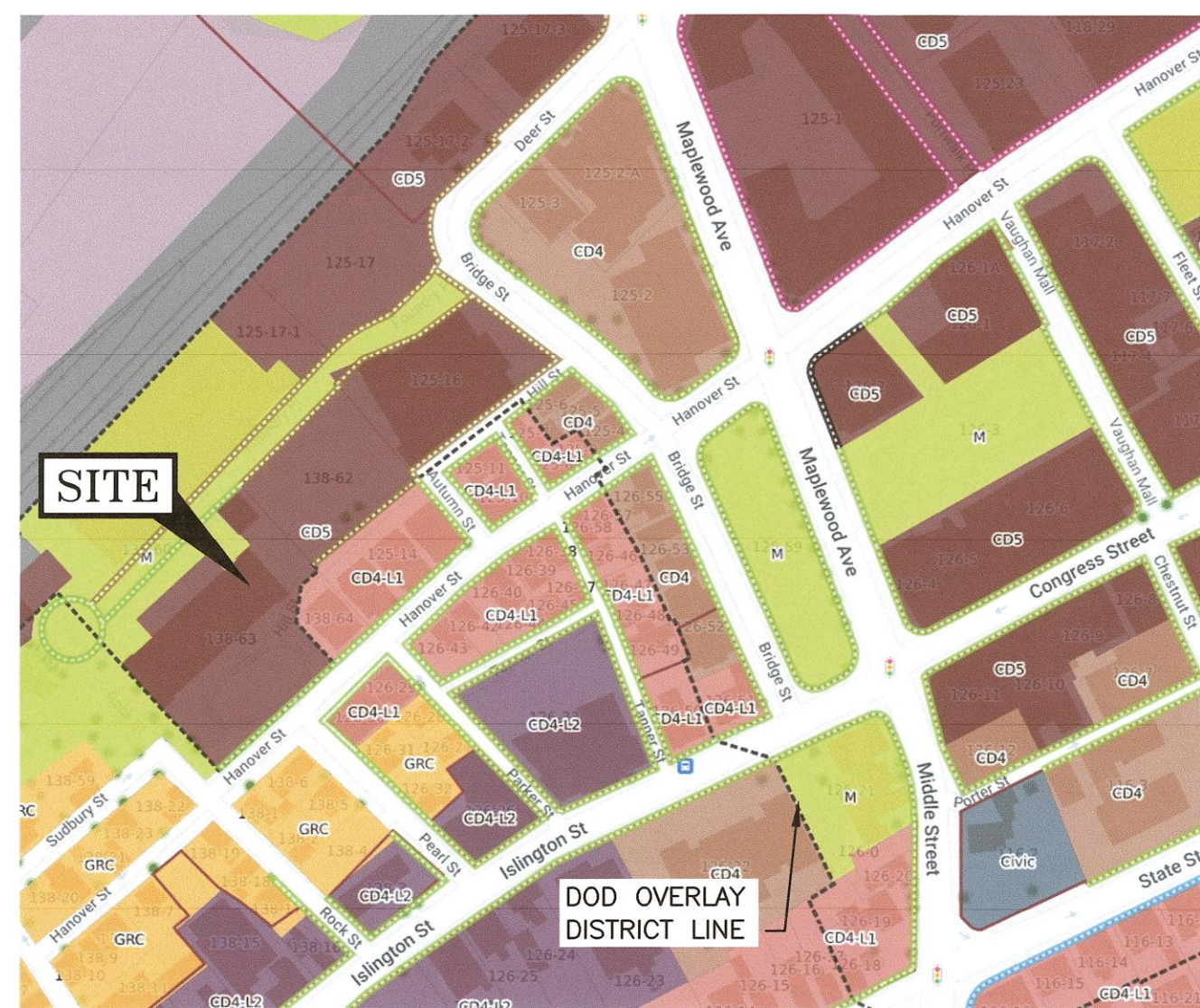
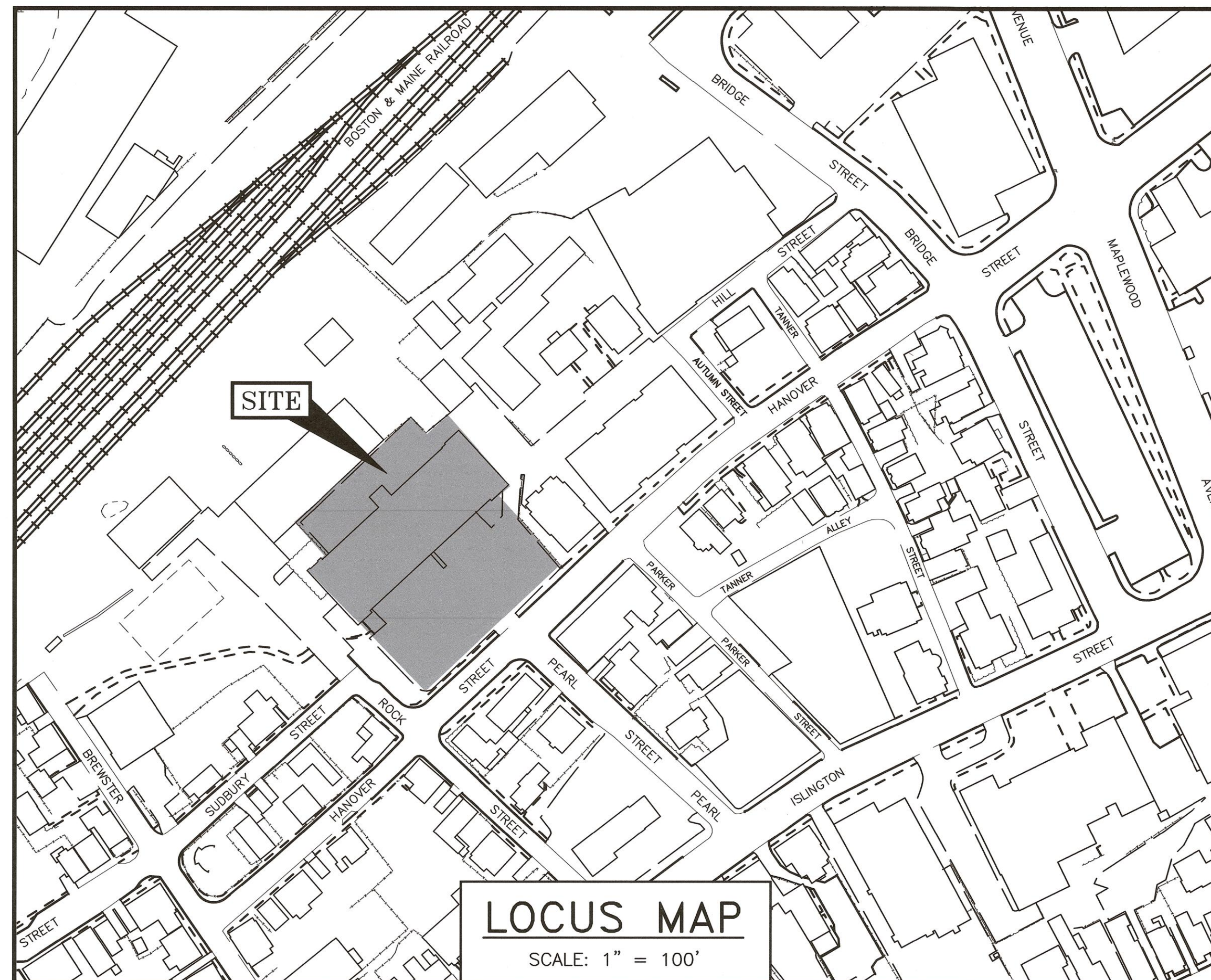

MAP 10.5A21A
CHARACTER DISTRICTS
AND CIVIC DISTRICTS

Character Districts
CD2 Character District 2
CD4 Character District 4
CD4-W Character District 4-W
CD4-L1 Character District 4-L1
CD4-L2 Character District 4-L2
Civic District
CDC Civic District
Municipal District
MDC Municipal District
Overlay Districts
OLDD Overlay District
DOLO Downtown Overlay District
HD Historic District

MAP 10.5A21B
BUILDING HEIGHT
STANDARDS

Height requirement area	Maximum building height*
1 Story	20'
2 Stories	35'
2 Stories (short 3rd)	35'
2-3 Stories	40'
2-3 Stories (short 4th)	45'
2-4 Stories	50'
2-4 Stories (short 5th)	60'
2-5 Stories	60'

*Penthouse Levels may exceed the building height by 2 feet.

UTILITY CONTACTS

ELECTRIC:
EVERSOURCE
1700 LAFAYETTE ROAD
PORTSMOUTH, N.H. 03801
Tel. (603) 436-7708, Ext. 555.5678
ATTN: MICHAEL BUSBY, P.E. (MANAGER)

NATURAL GAS:
UNITIL
325 WEST ROAD
PORTSMOUTH, N.H. 03801
Tel. (603) 294-5144
ATTN: DAVE BEAULIEU

CABLE:
COMCAST
155 COMMERCE WAY
PORTSMOUTH, N.H. 03801
Tel. (603) 679-5695 (X1037)
ATTN: MIKE COLLINS

SEWER & WATER:
PORTSMOUTH DEPARTMENT OF PUBLIC WORKS
680 PEVERLY HILL ROAD
PORTSMOUTH, N.H. 03801
Tel. (603) 427-1530
ATTN: JIM TOW

COMMUNICATIONS:
FAIRPOINT COMMUNICATIONS
JOE CONSIDINE
1575 GREENLAND ROAD
GREENLAND, N.H. 03840
Tel. (603) 427-5525

INDEX OF SHEETS

DWG. NO.	
-	SUBDIVISION PLAN
-	SITE ORTHOPHOTO
C1	EXISTING CONDITIONS PLAN
C2	DEMOLITION PLAN
C3	SITE PLAN
-	LICENSE AREA PLAN
C4	UTILITY PLAN
C5	PARKING PLAN
A2.1-3.1	ARCHITECTURAL PLANS

PORTSMOUTH APPROVAL CONDITIONS NOTE:
ALL CONDITIONS ON THIS PLAN SET SHALL REMAIN IN EFFECT IN PERPETUITY PURSUANT TO THE REQUIREMENTS OF THE CITY OF PORTSMOUTH SITE PLAN REVIEW REGULATIONS.

APPROVED BY THE PORTSMOUTH PLANNING BOARD

CHAIRMAN _____ DATE _____

DESIGN APPLICATION PLANS
PROPOSED DEVELOPMENT
361 HANOVER STREET
PORTSMOUTH, N.H.

HALEYWARD
ENGINEERING | ENVIRONMENTAL | SURVEYING
200 Griffin Rd. Unit 14
Portsmouth, New Hampshire 03801
603.430.9282
WWW.HALEYWARD.COM

PLAN SET SUBMITTAL DATE: 3 APRIL 2024

5010135.2977.01

NOTES:

- 1) PARCEL IS SHOWN ON THE CITY OF PORTSMOUTH ASSESSORS MAP 138 AS LOT 63.
- 2) OWNERS OF RECORD:
 UNIT A:
 361 HANOVER STEAM FACTORY, LLC
 41 INDUSTRIAL DRIVE UNIT 20
 EXETER, N.H. 03833
 6352/2959

 UNIT B:
 POWERHOUSE REALTY TRUST
 C/O ADAMS DAVID B. TRUSTEE
 210 GATES STREET
 PORTSMOUTH, NH 03801
 5419/1223
- 3) PARCEL IS NOT IN A SPECIAL FLOOD HAZARD AREA AS SHOWN ON FIRM PANEL 33015C0259F. EFFECTIVE JANUARY 29, 2021.
- 4) LOT AREAS:
 EXISTING
 43,245 S.F.
 0.9928 AC.

 PROPOSED LOT 1
 4,717 S.F.
 0.1083 AC.

 PROPOSED LOT 2
 38,528 S.F.
 0.8845 AC.

- 5) PARCEL IS LOCATED IN CHARACTER DISTRICT 5 (CD5), NORTH END INCENTIVE OVERLAY DISTRICT (NEIOD) AND DOWNTOWN OVERLAY DISTRICT.
- 6) THE PURPOSE OF THIS PLAN IS TO SHOW A PROPOSED SUBDIVISION OF TAX MAP 139, LOT 63 IN PORTSMOUTH, NH INTO 2 LOTS.
- 7) PARCEL IS BURDENED BY THE FOLLOWING EASEMENTS:
 A) ACCESS EASEMENT TO THE CITY OF PORTSMOUTH TO ALLOW ACCESS TO A PARKING AREA. SEE R.C.R.D. 4735/2971
 B) ACCESS EASEMENT TO HANOVER PLACE CONDOMINIUM ASSOCIATION. THIS EASEMENT TO BE RE-DEFINED AS SHOWN HEREON.
- 8) THE PARCEL HAS THE BENEFIT OF A REVOCABLE LICENSE BETWEEN THE CITY OF PORTSMOUTH AND THE KEARSARGE MILL UNIT ON THE PLAN ENTITLED "KEARSARGE MILL CONDOMINIUM HANOVER STREET, PORTSMOUTH, NH SITE PLAN AMENDMENT" PREPARED BY KIMBALL CHASE CONSULTING ENGINEERS DATED APRIL 14, 2006. LICENSE AND SITE PLAN ARE AVAILABLE WITH THE RECORDS OF THE CITY OF PORTSMOUTH. SEE ALSO PLAN REFERENCE #6.
- 9) PROPERTY CORNERS WILL BE SET PRIOR TO RECORDING.

NO.	DESCRIPTION	DATE
0	ISSUED FOR COMMENT	4/3/24
REVISIONS		

**SUBDIVISION PLAN
TAX MAP 138 - LOT 63**

**KEARSARGE MILL UNIT OWNERS
ASSOCIATION**

OWNERS: 361 HANOVER STEAM
FACTORY, LLC & POWERHOUSE REALTY
TRUST
FOUNDRY PLACE & HANOVER STREET
CITY OF PORTSMOUTH
COUNTY OF ROCKINGHAM
STATE OF NEW HAMPSHIRE

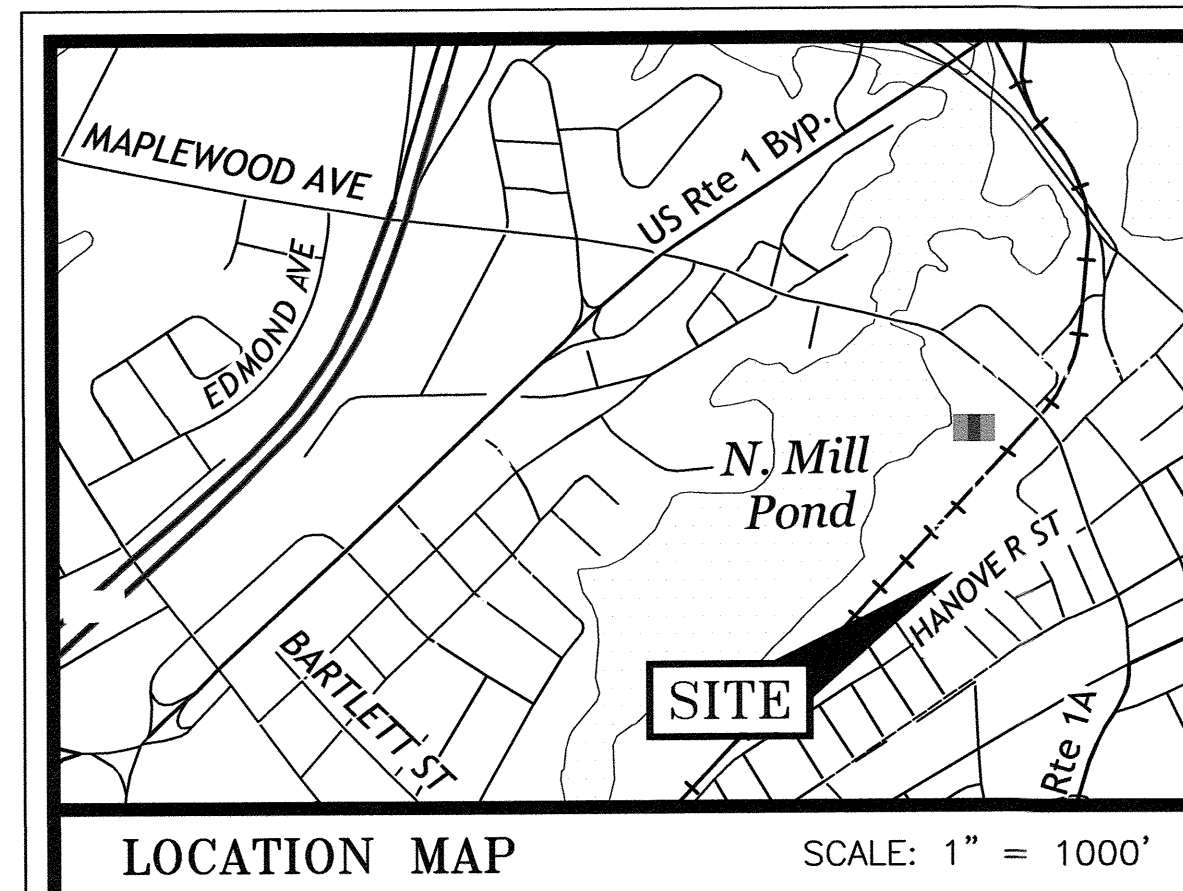

- PLAN REFERENCES:**
- 1) "PLAN OF LAND IN PORTSMOUTH, N.H. PORTSMOUTH MFG & POWER CO. TO FRANKIE BROOKS" BY JOHN W. DURGIN. DA TED FEBRUARY 1918. RCRD PLAN 078.
 - 2) "SUBDIVISION OF LAND OF PORTSMOUTH MFG. & POWER CO. PORTSMOUTH, N.H." BY JOHN W. DURGIN. DATED NOVEMBER 1925. RCRD PLAN #36B.
 - 3) "LAND IN PORTSMOUTH, N.H. PORTS. MFG. & POWER CO. TO HAROLD S. WOODS" BY JOHN W. DURGIN. DATED NOVEMBER 1926. RCRD PLAN #389.
 - 4) "CONDOMINIUM SITE PLAN FOR HANOVER PLACE CONDOMINIUM 349 HANOVER STREET COUNTY OF ROCKINGHAM PORTSMOUTH, NH" BY MILLETTE, SPRAGUE & COLWELL, INC. DATED SEPTEMBER 28, 2004 LAST REVISED DECEMBER 20, 2005. RCRD PLAN D-33379.
 - 5) "CONSOLIDATION & SUBDIVISION PLAN TAX MAP 125, LOT 17 & TAX MAP 138, LOT 62 DEER STREET ASSOCIATES BRIDGE, DEER & HILL STREETS CITY OF PORTSMOUTH COUNTY OF ROCKINGHAM STATE OF NEW HAMPSHIRE" BY AMBIT ENGINEERING, INC. DA TED JULY 2015. RCRD PLAN D-39699.
 - 6) "KEARSARGE MILLS CONDOMINIUM PLANS" BY KIMBALL CHASE COMPANY, INC. DATED APRIL 15, 1986. RCRD PLAN D-14855.
 - 7) "BOUNDARY LINE AGREEMENT PLAN KEARSARGE MILL CONDOMINIUMS PORTSMOUTH, N.H." BY JONES & BEACH ENGINEERS, INC. DATED APRIL 10, 1997 LAST REVISED APRIL 21, 1997. RCRD PLAN D-25421.
 - 8) "AMENDED SITE PLAN, KEARSARGE MILL CONDOMINIUMS, 1 HANOVER STREET PORTSMOUTH, NH" BY KIMBALL CHASE CONSULTING ENGINEERS DATED 04-14-06 AND LAST REVISED 02-16-07. RCRD PLAN D-34716.

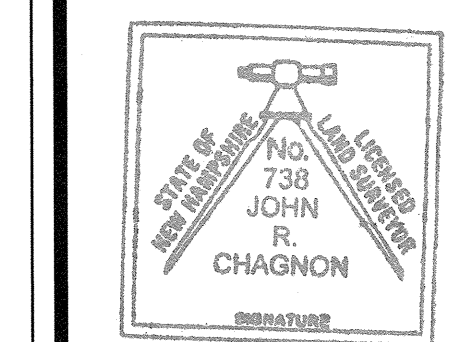

LENGTH TABLE

LINE	BEARING	DISTANCE
L1	N47°00'11"E	18.00'
L2	S43°03'50"E	1.78'
L3	N46°55'30"E	30.75'
L4	N43°04'30"W	29.30'
L5	N46°55'30"E	20.00'
L6	N43°04'30"W	1.80'
L7	N46°55'30"E	24.05'
L8	N42°30'12"W	17.65'
L9	S46°42'22"W	2.04'
L10	N43°17'38"W	43.88'
L11	N46°55'30"E	1.12'

"I CERTIFY THAT THIS PLAN WAS PREPARED UNDER MY DIRECT SUPERVISION, THAT IT IS THE RESULT OF A FIELD SURVEY BY THIS OFFICE AND HAS AN ACCURACY OF THE CLOSED TRAVERSE THAT EXCEEDS THE PRECISION OF 1:15,000."

John R. Chagnon 4.3.24
JOHN R. CHAGNON, LLS DATE

APPROVED BY THE PORTSMOUTH PLANNING BOARD

CHAIRMAN DATE

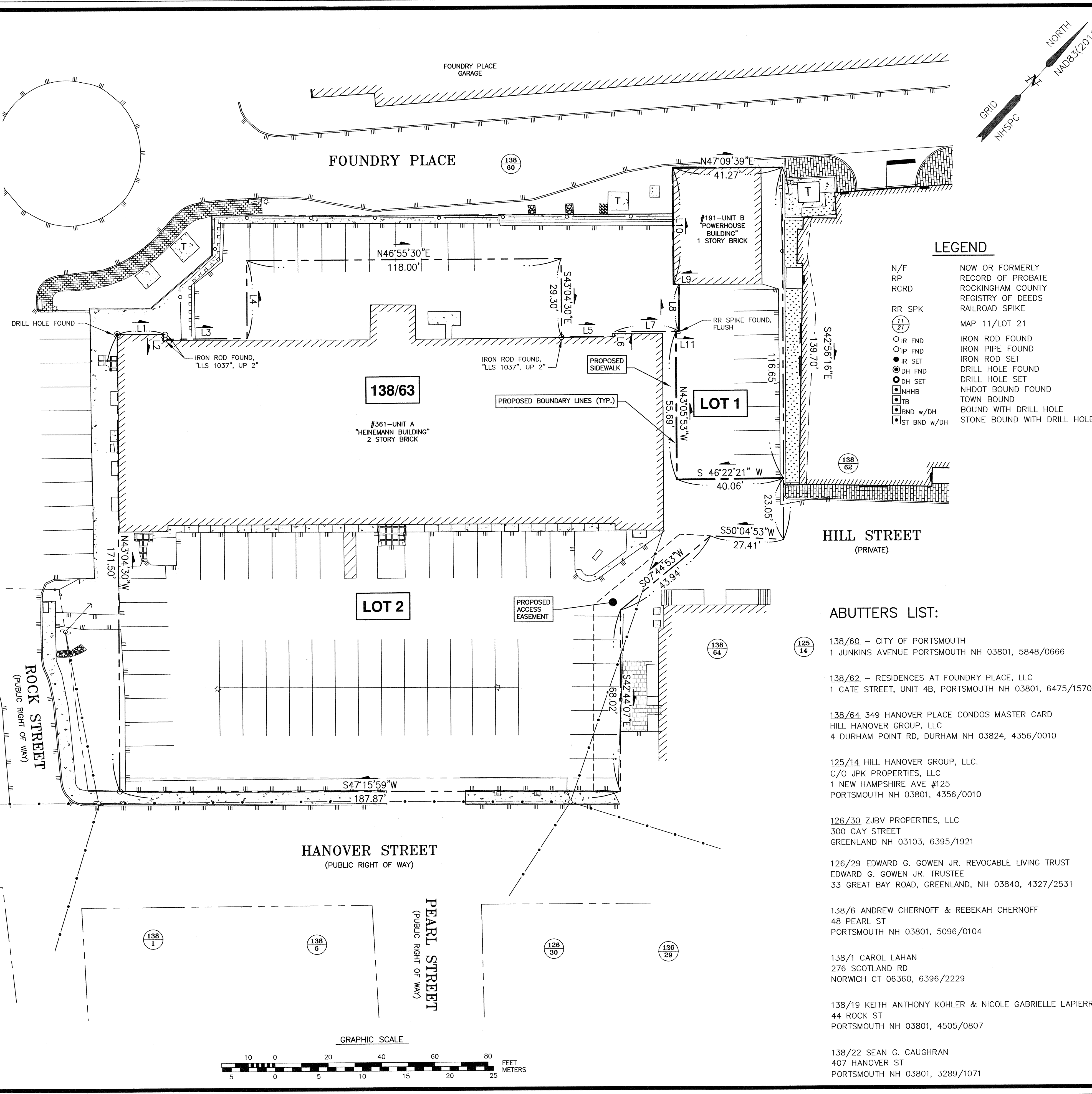

- LEGEND**
- N/F NOW OR FORMERLY
 - RP RECORD OF PROBATE
 - RCRD ROCKINGHAM COUNTY
 - RR SPK RAILROAD SPIKE
 - IR FND IRON ROD FOUND
 - IP FND IRON PIPE FOUND
 - IR SET IRON ROD SET
 - DH FND DRILL HOLE FOUND
 - DH SET DRILL HOLE SET
 - NHNB NHDOT BOUND FOUND
 - TB TOWN BOUND
 - BND w/DH BOUND WITH DRILL HOLE
 - ST BND w/DH STONE BOUND WITH DRILL HOLE

HILL STREET
(PRIVATE)

- ABUTTERS LIST:**
- 138/60 - CITY OF PORTSMOUTH
1 JUNKINS AVENUE PORTSMOUTH NH 03801, 5848/0666
 - 138/62 - RESIDENCES AT FOUNDRY PLACE, LLC
1 CATE STREET, UNIT 4B, PORTSMOUTH NH 03801, 6475/1570
 - 138/64 349 HANOVER PLACE CONDOS MASTER CARD
HILL HANOVER GROUP, LLC
4 DURHAM POINT RD, DURHAM NH 03824, 4356/0010
 - 125/14 HILL HANOVER GROUP, LLC.
C/O JPK PROPERTIES, LLC
1 NEW HAMPSHIRE AVE #125
PORTSMOUTH NH 03801, 4356/0010
 - 126/30 ZJBV PROPERTIES, LLC
300 GAY STREET
GREENLAND NH 03103, 6395/1921
 - 126/29 EDWARD G. GOWEN JR. REVOCABLE LIVING TRUST
EDWARD G. GOWEN JR. TRUSTEE
33 GREAT BAY ROAD, GREENLAND, NH 03840, 4327/2531
 - 138/6 ANDREW CHERNOFF & REBEKAH CHERNOFF
48 PEARL ST
PORTSMOUTH NH 03801, 5096/0104
 - 138/1 CAROL LAHAN
276 SCOTLAND RD
NORWICH CT 06360, 6396/2229
 - 138/19 KEITH ANTHONY KOHLER & NICOLE GABRIELLE LAPIERRE
44 ROCK ST
PORTSMOUTH NH 03801, 4505/0807
 - 138/22 SEAN G. CAUGHRAN
407 HANOVER ST
PORTSMOUTH NH 03801, 3289/1071

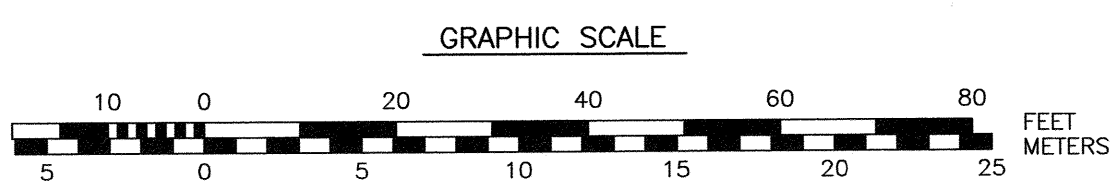



- NOTES:**
- 1) PARCEL IS SHOWN ON THE CITY OF PORTSMOUTH ASSESSORS MAP 138 AS LOT 63.
 - 2) APPLICANT:
 361 HANOVER STEAM FACTORY, LLC
 41 INDUSTRIAL DRIVE UNIT 20
 EXETER, NH 03833
 6352/2959
 - 3) THE PURPOSE OF THIS PLAN IS TO SHOW SITE FEATURES AS OF FEBRUARY 2023 ON THE CITY OF PORTSMOUTH ASSESSOR'S MAP 138 LOT 63.

LICENSE AREA
 7,500 S.F.

138/60

#191-UNIT B
 "POWERHOUSE
 BUILDING"
 1 STORY BRICK

138/63

#361-UNIT A
 "HEINEMANN BUILDING"
 2 STORY BRICK

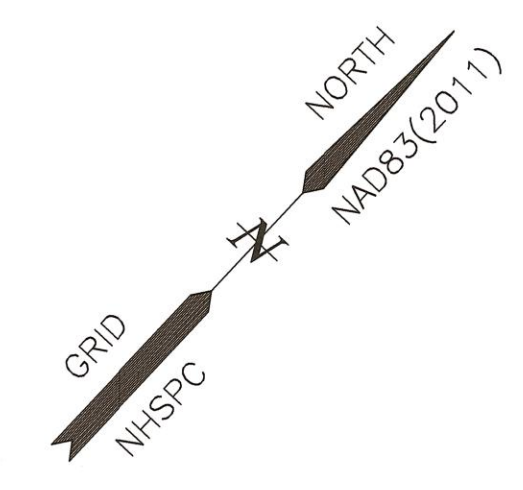

NO.	DESCRIPTION	DATE
0	ISSUED FOR COMMENT	4/3/24
REVISIONS		

SITE ORTHOPHOTO
TAX MAP 138 - LOT 63
361 HANOVER STEAM FACTORY, LLC
FOUNDRY PLACE & ROCK STREET
CITY OF PORTSMOUTH
COUNTY OF ROCKINGHAM
STATE OF NEW HAMPSHIRE

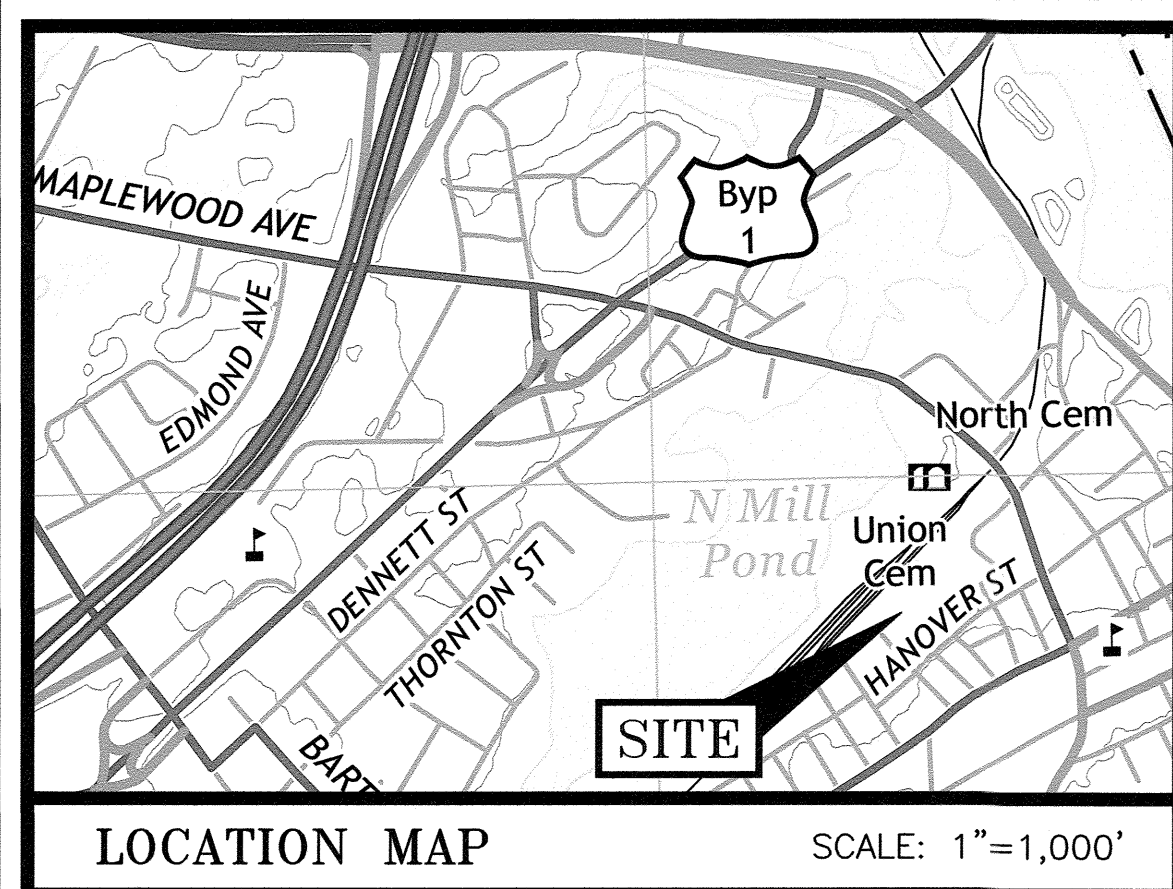

- NOTES:**
- PARCEL IS SHOWN ON THE CITY OF PORTSMOUTH ASSESSOR'S MAP 138 AS LOT 63.
 - OWNER OF RECORD:
 361 HANOVER STEAM FACTORY, LLC
 41 INDUSTRIAL DRIVE UNIT 20
 EXETER, N.H. 03833
 6352/2959
 - PARCEL IS NOT IN A FLOOD HAZARD ZONE AS SHOWN ON FIRM PANEL 33015C0259F. JANUARY 29 2021.
 - EXISTING LOT AREA:
 38,528 S.F.
 - PARCEL IS LOCATED IN CHARACTER DISTRICT 5 (CD5), NORTH END INCENTIVE OVERLAY DISTRICT, AND DOWNTOWN OVERLAY DISTRICT.
 - DIMENSIONAL REQUIREMENTS:
 SEE ZONING ORDINANCE
 - THE PURPOSE OF THIS PLAN IS TO SHOW THE EXISTING CONDITIONS ON PORTSMOUTH ASSESSOR'S MAP 138 AS LOT 63, AS AMENDED.
 - VERTICAL DATUM IS NAVD88. BASIS OF VERTICAL DATUM IS REDUNDANT RTN GNSS OBSERVATIONS.

DRAINAGE STRUCTURE TABLE

STRUCTURE	PROP/EX	RIM	PIPE SIZE/TYPE	INVERT IN	INVERT OUT	DIRECTION	
CB 1	EX	20.66	8" CPP	17.51	17.46	SW	
CB 2	EX	20.35	12" CPP	15.80	15.70	N	
			8" CPP	16.50		NE	
			8" CPP	16.50		SE	
CB 3	EX	19.29	12" CPP	16.24	15.64	NW	
			8" CPP	16.24		W	
			8" CPP	16.29		S	
CB 4	EX	18.90	12" CPP		15.65	SE	
CB 5	EX	15.00	12" CPP		10.00	SW	
			12" CPP		10.00	SE	
CB 6	EX	15.60	12" CPP		12.85	SW	
			8" CPP		13.20	NE	
CB 7	EX	17.43	8" CPP		16.28	SW	
CB 8	EX	12.15	12" CPP		7.45	NW	
CB 9&10	EX	9.76	12" CPP		5.86	NE	
CB 11	EX	10.07	12" CPP		6.17	SE	
CB 12	EX	10.22	12" CPP		6.92	W	
DMH 1	EX	19.81	12" CPP		15.56	SW	
			12" CPP		15.56	E	
DMH 2	EX	19.08	12" CPP		15.03	SW	
			12" CPP		15.03	NE	
			12" CPP		15.43	NW	
			12" CPP		15.43	SE	
DMH 3	EX	15.30	12" CPP		10.65	NW	
			12" CPP		10.65	NE	
DMH 4	EX	11.86	18" CPP		5.46	NW	
			15" CPP		5.56	NE	
			4" PVC		9.36	S	
DMH 5	EX	9.87	NO DATA				
DMH 6	EX	11.84	NO DATA				
DMH 7	EX	10.19	18" CPP		6.29	SW	
			12" CPP		6.44	NW	
			12" CPP		6.39	E	

SEWER STRUCTURE TABLE

STRUCTURE	PROP/EX	RIM	PIPE SIZE/TYPE	INVERT IN	INVERT OUT	DIRECTION
SMH 1	EX	20.06	15" PVC		14.36	NE
			8" PVC		14.41	SE
SMH 2	EX	19.31	8" PVC		12.91	SW
SMH 3	EX	19.15	8" PVC		11.45	SW
			8" PVC		11.60	NE
			8" PVC		13.90	SE
SMH 4	EX	12.23	48" CI		-0.77	NW
			48" CI		-0.77	NE

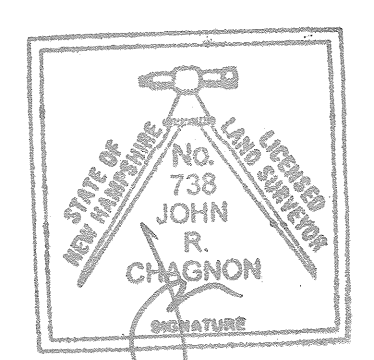
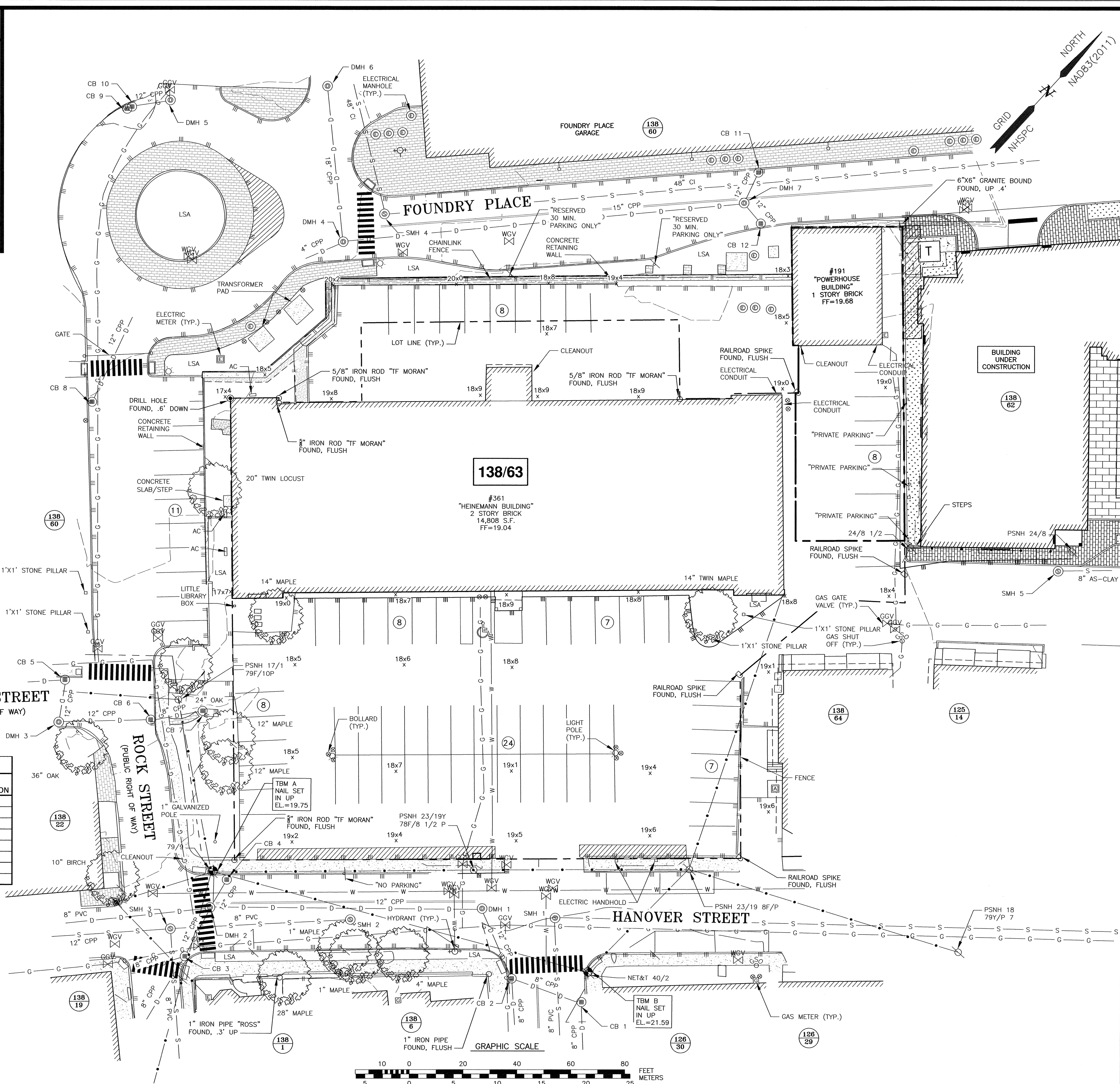

"I CERTIFY THAT THIS PLAN WAS PREPARED UNDER MY DIRECT SUPERVISION, THAT IT IS THE RESULT OF A FIELD SURVEY BY THIS OFFICE AND HAS AN ACCURACY OF THE CLOSED TRAVERSE THAT EXCEEDS THE PRECISION OF 1:15,000."

John R. Chagnon 4.3.24
 JOHN R. CHAGNON, LLS DATE

**SITE REDEVELOPMENT
 361 HANOVER STREET
 PORTSMOUTH, N.H.**

NO.	DESCRIPTION	DATE
2	ISSUED FOR REVIEW	4/3/24
1	UPDATE E.C. & ADD SPOT GRADES	2/28/24
0	ISSUED FOR COMMENT	1/31/24

SCALE: 1"=20'
 JANUARY 2024

EXISTING CONDITIONS PLAN
C1

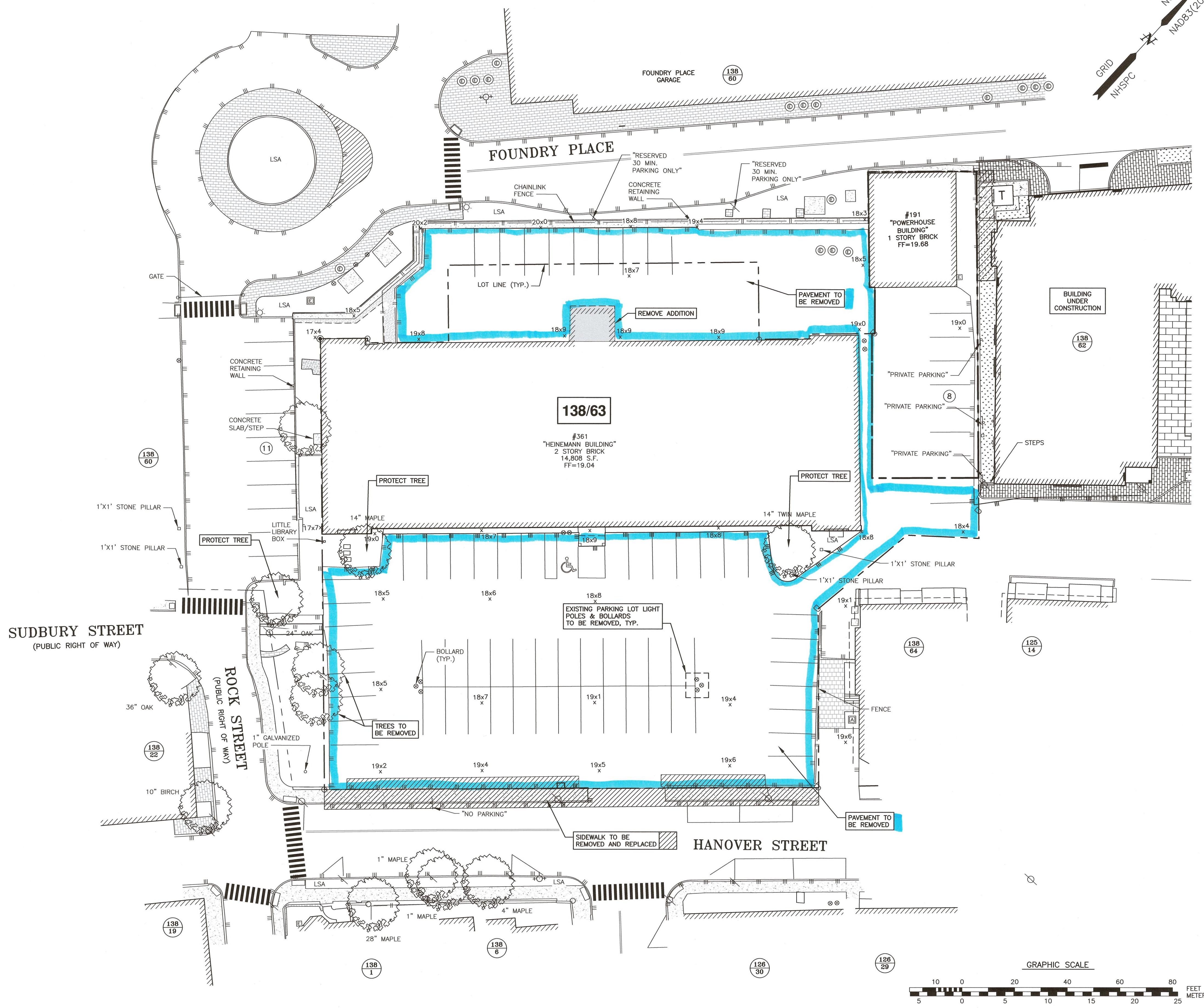
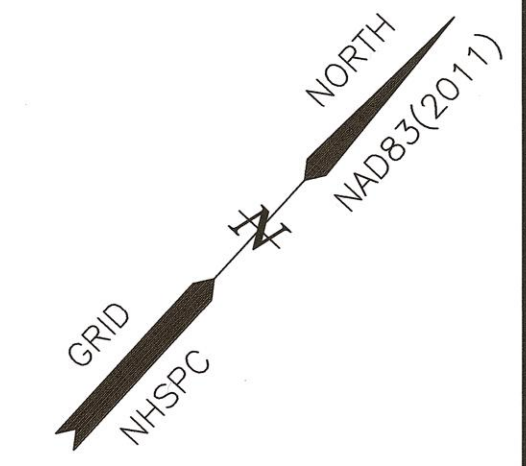

- NOTES:**
- 1) THE CONTRACTOR SHALL NOTIFY DIG SAFE AT 1-888-DIG-SAFE (1-888-344-7233) AT LEAST 72 HOURS PRIOR TO COMMENCING ANY EXCAVATION ON PUBLIC OR PRIVATE PROPERTY.
 - 2) UNDERGROUND UTILITY LOCATIONS ARE BASED UPON BEST AVAILABLE EVIDENCE AND ARE NOT FIELD VERIFIED. LOCATING AND PROTECTING ANY ABOVEGROUND OR UNDERGROUND UTILITIES IS THE SOLE RESPONSIBILITY OF THE CONTRACTOR AND/OR THE OWNER. UTILITY CONFLICTS SHOULD BE REPORTED AT ONCE TO THE DESIGN ENGINEER.
 - 3) CONTRACTOR SHALL INSTALL AND MAINTAIN EROSION CONTROL MEASURES IN ACCORDANCE WITH THE "NEW HAMPSHIRE STORMWATER MANUAL, VOLUME 3, EROSION AND SEDIMENT CONTROLS DURING CONSTRUCTION. (NHDES DECEMBER 2008).
 - 4) COORDINATE ACCESS IN STREET/ROW AREAS ADJACENT TO DEMOLITION TO INSURE SAFE PASSAGE. UTILIZE DETOURS IF NEEDED.
 - 5) EXISTING UTILITIES TO BE ABANDONED SHALL BE REMOVED TO THE UTILITY MAIN AND CAPPED PER THE UTILITY COMPANY REQUIREMENT.

**SITE REDEVELOPMENT
 361 HANOVER STREET
 PORTSMOUTH, N.H.**

NO.	DESCRIPTION	DATE
0	ISSUED FOR COMMENT	4/3/24
REVISIONS		



SCALE: 1"=20' JANUARY 2024

DEMOLITION PLAN **C2**

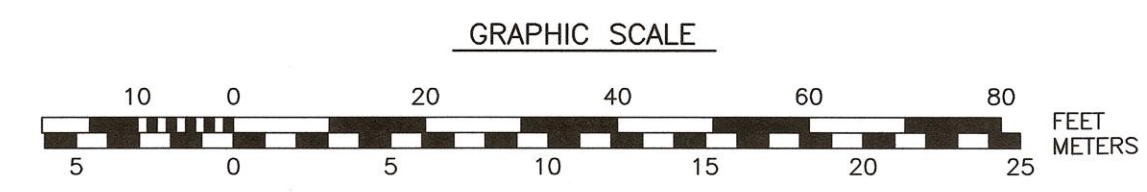

ZONING DEVELOPMENT STANDARD			
CDS: CHARACTER DISTRICT 5, DOD: DOWNTOWN OVERLAY DISTRICT			
	REQUIRED	EXISTING	PROPOSED
Height	2-3 stories 40'	2 Stories / 18' +/-	3 stories / 40'
Penthouses	may exceed bldg height by 2'	N/A	N/A
Roof appurtenance	may exceed bldg height by 10'	< 10'	< 10'
Facade Types		N/A	N/A
Building Types	commercial, live-work, mixed use, flex space & community.	Commercial	Mixed Use
Front (principle) max	5	99'	1'
Front (secondary) max	5	0'	0'
Side	NR	NR	NR
Rear yard	5'	N/A	N/A
Front lotline buildout	80% min	100%	95%
Lot area (sf)	NR	N/A	N/A
LOT area per dwelling	NR	N/A	N/A
Building coverage, maximum	95%	38%	75%
Maximum building footprint	20,000	14,808	18,080
Ground floor area per use, max	15,000	14,808	7,660
Open space, minimum	5%	<5%	5.3%
Permitted uses		Commercial	Mixed use
Block length, max (ft)	225	205'	178'
Facade modulation length, max (ft)	100	205	79
Entrance spacing, max (ft)	50	>50'	<50'
Floor height above sidewalk, max	36"	0'	0'
Ground story height, min	12'	10'	12'
Second story height, min	10'	10'	10'
Glazing, shopfront, min	70%	N/A	N/A
Glazing, other	20%-50%	> 20%	> 20%
Roof types	flat, gable, hip, gambrel, mansard	Flat	Mansard

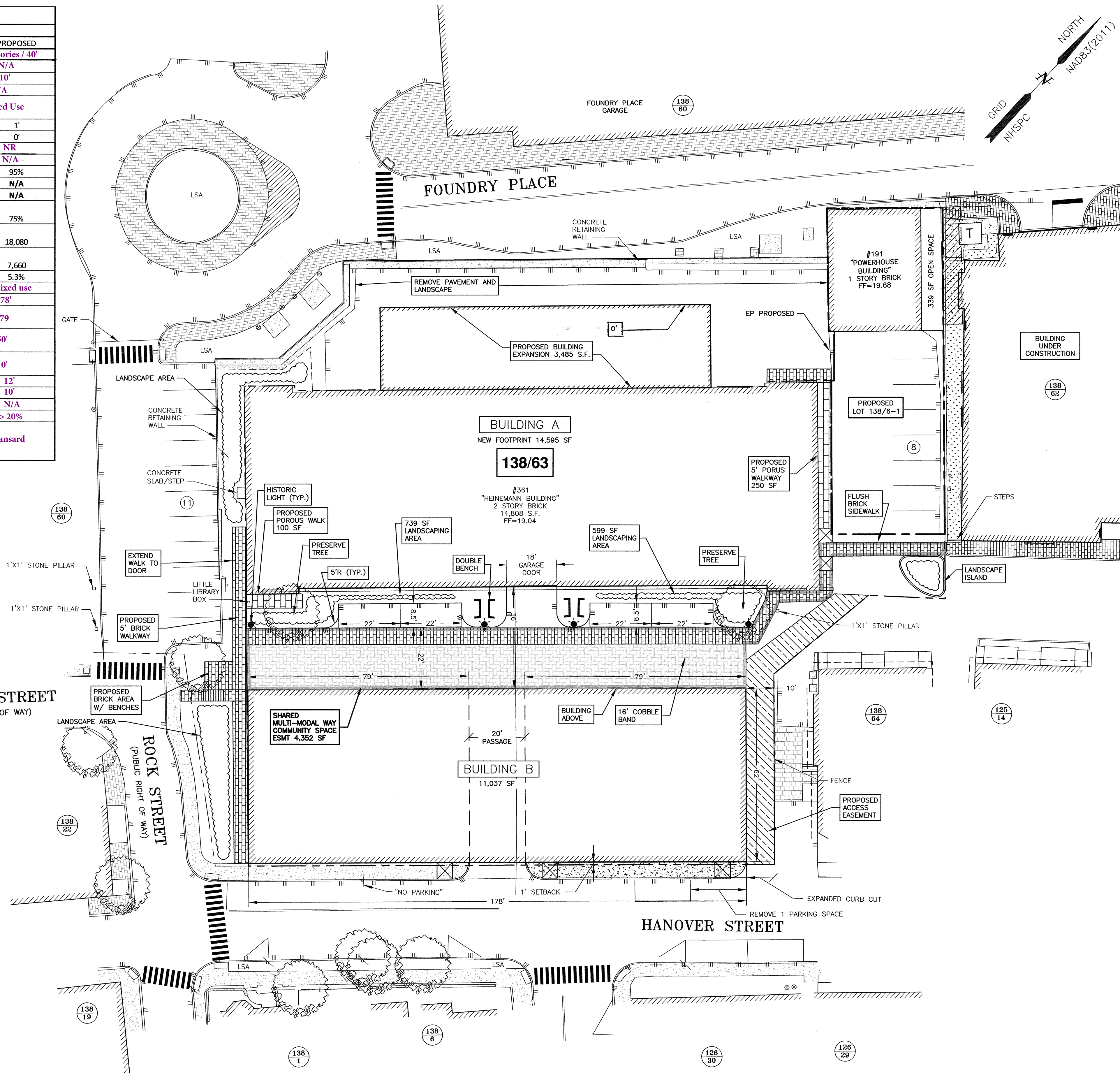

- NOTES:**
- PARCEL IS SHOWN ON THE CITY OF PORTSMOUTH ASSESSOR'S MAP 138 AS LOT 63.
 - APPLICANT:
361 HANOVER STEAM FACTORY, LLC
41 INDUSTRIAL DRIVE UNIT 20
EXETER, N.H. 03833
 - PARCEL IS NOT IN A FLOOD HAZARD ZONE AS SHOWN ON FIRM PANEL 33015C0259F. JANUARY 29 2021.
- PROPOSED LOT AREAS:
 LOT 138/63
38,528 S.F.±
0.8845 AC
 LOT 138/63-1
4,717 S.F.
0.1083 AC
- PARCEL IS LOCATED IN CHARACTER DISTRICT 5 (CD5), NORTH END INCENTIVE OVERLAY, AND DOWNTOWN OVERLAY DISTRICT.
- DIMENSIONAL REQUIREMENTS:
 *SEE PORTSMOUTH ZONING ORDINANCE AND TABLE.
 MINIMUM LOT AREA: NR
 SETBACKS:
 FRONT: 5 FEET (MAXIMUM)
 SIDE: NR
 REAR: 5 FEET
 MAXIMUM BUILDING COVERAGE: 95%
- THE PURPOSE OF THIS PLAN IS TO SHOW THE PROPOSED SITE DEVELOPMENT ON ASSESSOR'S MAP 138 LOT 63.
 - VERTICAL DATUM IS NAVD88. BASIS OF VERTICAL DATUM IS REDUNDANT RTN GNSS OBSERVATIONS.
 - PROPOSED USE: 36 RESIDENTIAL DWELLING UNITS
 - 3,853 SF COMMUNITY SPACE REQUIRED
4,352 SF COMMUNITY SPACE PROVIDED
1,925 SF OPEN SPACE REQUIRED
2,038 SF OPEN SPACE PROVIDED

**SITE REDEVELOPMENT
 361 HANOVER STREET
 PORTSMOUTH, N.H.**

NO.	DESCRIPTION	DATE
1	Zoning Table	4/7/24
0	ISSUED FOR COMMENT	4/3/24

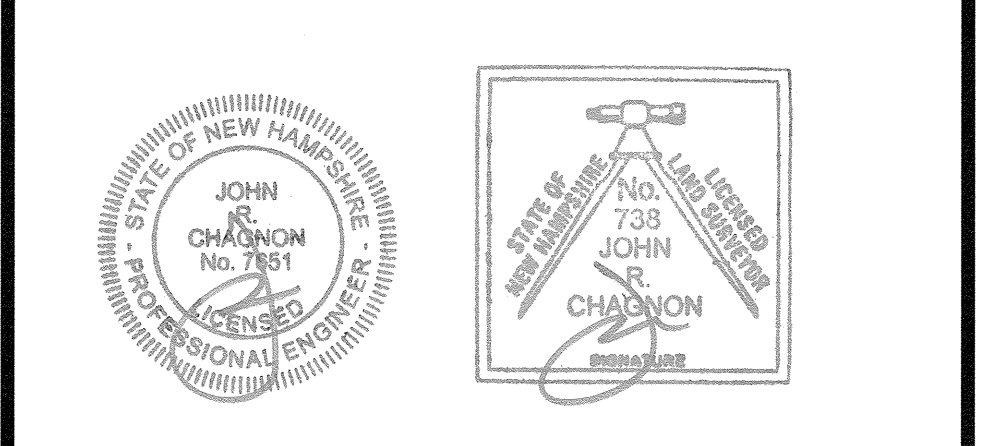

SCALE: 1"=20' JANUARY 2024

SITE PLAN **C3**

THIS SITE PLAN SHALL BE RECORDED IN THE ROCKINGHAM COUNTY REGISTRY OF DEEDS.
 ALL IMPROVEMENTS SHOWN ON THIS SITE PLAN SHALL BE CONSTRUCTED AND MAINTAINED IN ACCORDANCE WITH THE PLAN BY THE PROPERTY OWNER AND ALL FUTURE PROPERTY OWNERS. NO CHANGES SHALL BE MADE TO THIS SITE PLAN WITHOUT THE EXPRESS APPROVAL OF THE PORTSMOUTH PLANNING DIRECTOR.
 APPROVED BY THE PORTSMOUTH PLANNING BOARD

CHAIRMAN _____ DATE _____

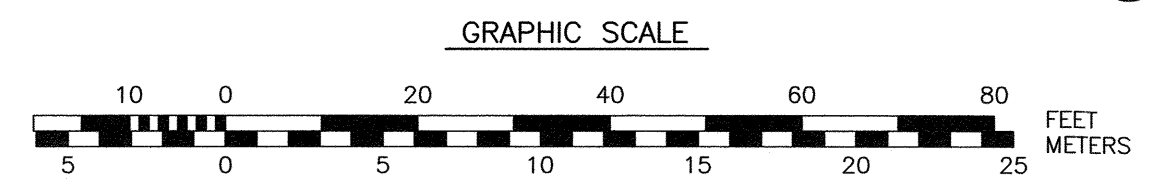

NOTES:

- 1) PARCEL IS SHOWN ON THE CITY OF PORTSMOUTH ASSESSORS MAP 138 AS LOT 60.
- 2) OWNERS OF RECORD:
LOT 60
CITY OF PORTSMOUTH
JUNKINS AVENUE
PORTSMOUTH, NH 03801

LOT 63 - UNIT A
361 HANOVER STEAM FACTORY, LLC
41 INDUSTRIAL DRIVE UNIT 20
EXETER, N.H. 03833
6352/2959
- 3) PARCEL IS NOT IN A SPECIAL FLOOD HAZARD AREA AS SHOWN ON FIRM PANEL 33015C0259F. EFFECTIVE JANUARY 29, 2021.
- 4) LOT AREA: 38,528 S.F.
- 5) PARCEL IS LOCATED IN CHARACTER DISTRICT 5 (CD5) AND DOWNTOWN OVERLAY DISTRICT.
- 6) THE PURPOSE OF THIS PLAN IS TO SHOW A PROPOSED LICENSE AREA ON TAX MAP 139, LOT 60 TO BENEFIT TAX MAP 138, LOT 63 IN PORTSMOUTH, NH.
- 7) THE LICENSE AGREEMENT BETWEEN THE CITY OF PORTSMOUTH AND 361 HANOVER STEAM FACTORY, LLC WILL REPLACE THE EXISTING PARKING LICENSE AGREEMENT AND ACCESS AGREEMENT RECORDED AT DEED BOOK 4735 PAGE 2971 AND PROVIDE A PUBLIC AND PRIVATE LANDSCAPING EASEMENT TO 361 HANOVER STEAM FACTORY, LLC.

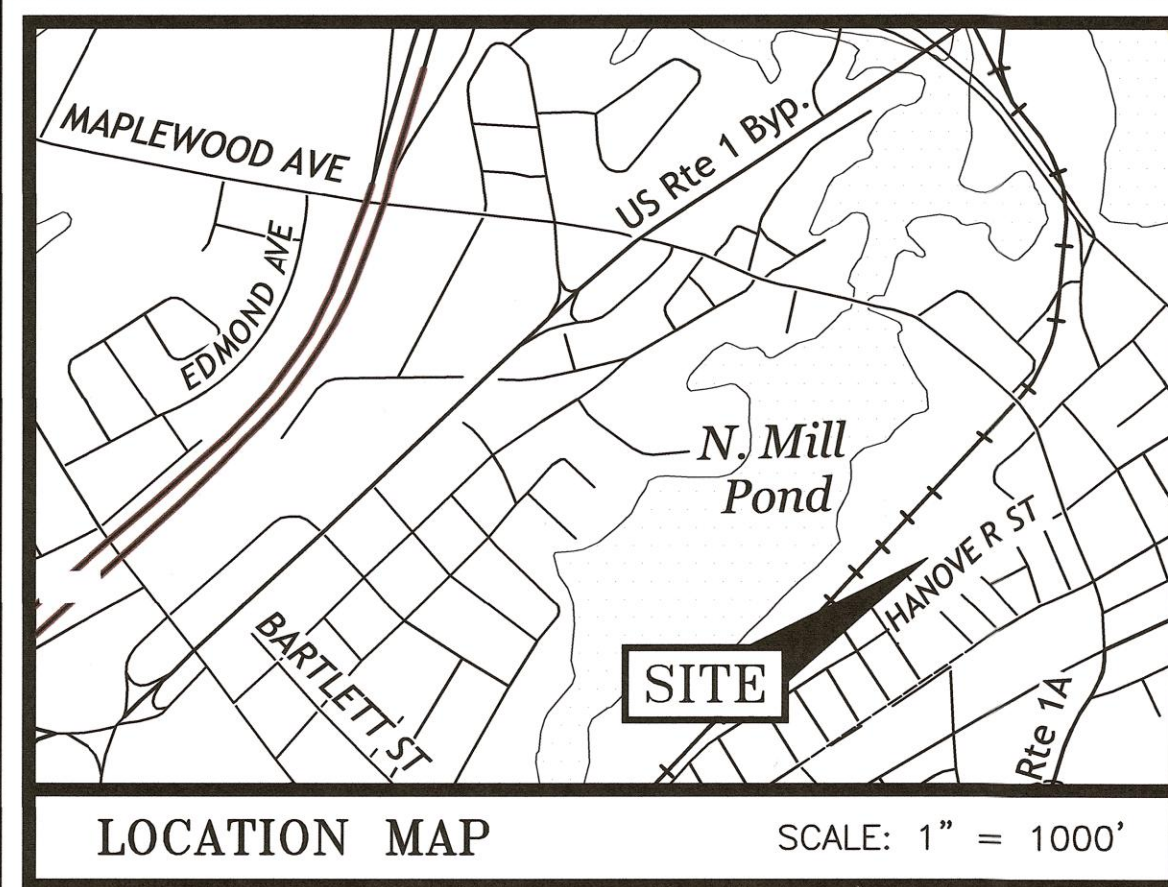

PLAN REFERENCES:

- 1) "PLAN OF LAND IN PORTSMOUTH, N.H. PORTSMOUTH MFG & POWER CO. TO FRANKIE BROOKS" BY JOHN W. DURGIN. DA TED FEBRUARY 1918. RCRD PLAN 078.
- 2) "SUBDIVISION OF LAND OF PORTSMOUTH MFG. & POWER CO. PORTSMOUTH, N.H." BY JOHN W. DURGIN. DATED NOVEMBER 1925. RCRD PLAN #368.
- 3) "LAND IN PORTSMOUTH, N.H. PORTS. MFG. & POWER CO. TO HAROLD S. WOODS" BY JOHN W. DURGIN. DATED NOVEMBER 1926. RCRD PLAN #389.
- 4) "CONDOMINIUM SITE PLAN FOR HANOVER PLACE CONDOMINIUM 349 HANOVER STREET COUNTY OF ROCKINGHAM PORTSMOUTH, NH" BY MILLETTE, SPRAGUE & COLWELL, INC. DATED SEPTEMBER 28, 2004 LAST REVISED DECEMBER 20, 2005. RCRD PLAN D-33379.
- 5) "CONSOLIDATION & SUBDIVISION PLAN TAX MAP 125, LOT 17 & TAX MAP 138, LOT 62 DEER STREET ASSOCIATES BRIDGE, DEER & HILL STREETS CITY OF PORTSMOUTH COUNTY OF ROCKINGHAM STATE OF NEW HAMPSHIRE" BY AMBIT ENGINEERING, INC. DA TED JULY 2015. RCRD PLAN D-39699.
- 6) "KEARSARGE MILLS CONDOMINIUM PLANS" BY KIMBALL CHASE COMPANY, INC. DATED APRIL 15, 1986. RCRD PLAN D-14855.
- 7) "BOUNDARY LINE AGREEMENT PLAN KEARSARGE MILL CONDOMINIUMS PORTSMOUTH, N.H." BY JONES & BEACH ENGINEERS, INC. DATED APRIL 10, 1997 LAST REVISED APRIL 21, 1997. RCRD PLAN D-25421.
- 8) "AMENDED SITE PLAN, KEARSARGE MILL CONDOMINIUMS, 1 HANOVER STREET PORTSMOUTH, NH" BY KIMBALL CHASE CONSULTING ENGINEERS DATED 04-14-06 AND LAST REVISED 02-16-07. RCRD PLAN D-34716.

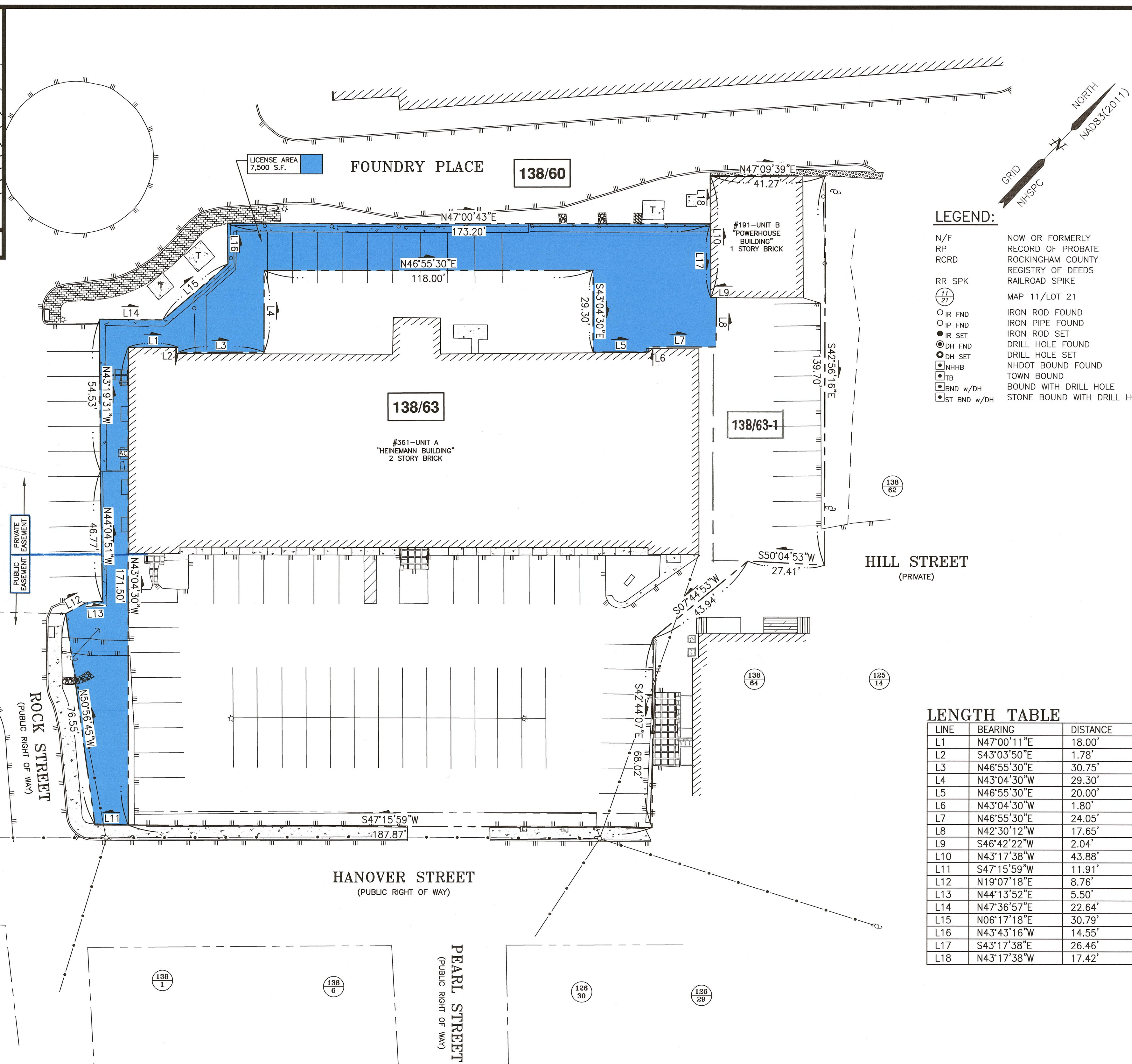

LEGEND:

- N/F NOW OR FORMERLY
- RP RECORD OF PROBATE
- RCRD ROCKINGHAM COUNTY REGISTRY OF DEEDS
- RR SPK RAILROAD SPIKE
- (11) MAP 11/LOT 21
- IR FND IRON ROD FOUND
- IP FND IRON PIPE FOUND
- IR SET IRON ROD SET
- DH FND DRILL HOLE FOUND
- DH SET DRILL HOLE SET
- NHHB NHDOT BOUND FOUND
- TB TOWN BOUND
- BND w/DH BOUND WITH DRILL HOLE
- ST BND w/DH STONE BOUND WITH DRILL HOLE

LENGTH TABLE

LINE	BEARING	DISTANCE
L1	N47°00'11"E	18.00'
L2	S43°03'50"E	1.78'
L3	N46°55'30"E	30.75'
L4	N43°04'30"W	29.30'
L5	N46°55'30"E	20.00'
L6	N43°04'30"W	1.80'
L7	N46°55'30"E	24.05'
L8	N42°30'12"W	17.65'
L9	S46°42'22"W	2.04'
L10	N43°17'38"W	43.88'
L11	S47°15'59"W	11.91'
L12	N19°07'18"E	8.76'
L13	N44°13'52"E	5.50'
L14	N47°36'57"E	22.64'
L15	N06°17'18"E	30.79'
L16	N43°43'16"W	14.55'
L17	S43°17'38"E	26.46'
L18	N43°17'38"W	17.42'

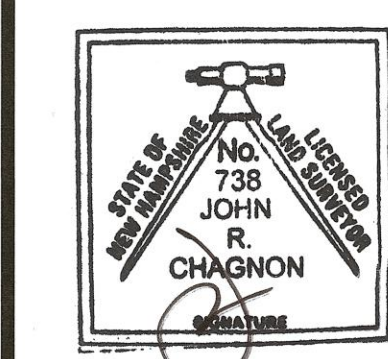

"I CERTIFY THAT THIS PLAN WAS PREPARED UNDER MY DIRECT SUPERVISION, THAT IT IS THE RESULT OF A FIELD SURVEY BY THIS OFFICE AND HAS AN ACCURACY OF THE CLOSED TRAVERSE THAT EXCEEDS THE PRECISION OF 1:15,000."

John R. Chagnon
JOHN R. CHAGNON, LLS
DATE 3.21.24

APPROVED BY THE PORTSMOUTH PLANNING BOARD

CHAIRMAN _____ DATE _____

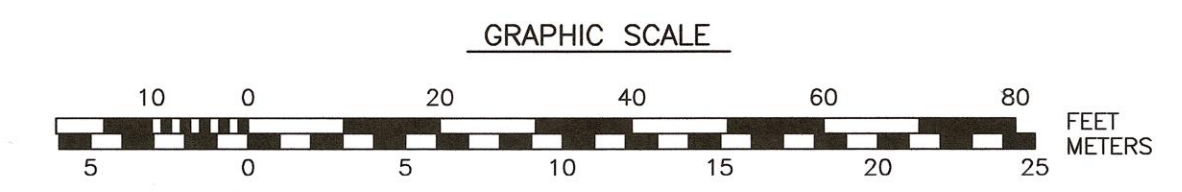

PROPOSED LICENSE AREA PLAN
TAX MAP 138 - LOT 63
CITY OF PORTSMOUTH
TO
361 HANOVER STEAM
FACTORY, LLC
FOUNDY PLACE & ROCK STREET
CITY OF PORTSMOUTH
COUNTY OF ROCKINGHAM
STATE OF NEW HAMPSHIRE

UTILITY NOTES:

- 1) SEE EXISTING CONDITIONS PLAN FOR BENCHMARK INFORMATION.
- 2) COORDINATE ALL UTILITY WORK WITH APPROPRIATE UTILITY.
- 3) CONTRACTOR SHALL COORDINATE ALL ELECTRIC WORK INCLUDING BUT NOT LIMITED TO: CONDUIT CONSTRUCTION, MANHOLE CONSTRUCTION, UTILITY POLE CONSTRUCTION, OVERHEAD WIRE RELOCATION, AND TRANSFORMER CONSTRUCTION WITH POWER COMPANY.
- 4) ALL WATER MAIN INSTALLATIONS SHALL BE CLASS 52, POLYWRAPPED, CEMENT LINED DUCTILE IRON PIPE.
- 5) ALL WATERMAIN INSTALLATIONS SHALL BE PRESSURE TESTED AND CHLORINATED AFTER CONSTRUCTION AND BEFORE ACTIVATING THE SYSTEM. CONTRACTOR SHALL COORDINATE WITH THE CITY OF PORTSMOUTH.
- 6) ALL SEWER PIPE SHALL BE PVC SDR 35 UNLESS OTHERWISE STATED.
- 7) ALL WORK WITHIN CITY R.O.W. SHALL BE COORDINATED WITH CITY OF PORTSMOUTH.
- 8) CONTRACTOR SHALL MAINTAIN UTILITY SERVICES TO ABUTTING PROPERTIES THROUGHOUT CONSTRUCTION.
- 9) ANY CONNECTION TO EXISTING WATERMAIN SHALL BE CONSTRUCTED BY THE CITY OF PORTSMOUTH.
- 10) EXISTING UTILITIES TO BE REMOVED SHALL BE CAPPED AT THE MAIN AND MEET THE DEPARTMENT OF PUBLIC WORKS STANDARDS FOR CAPPING OF WATER AND SEWER SERVICES.
- 11) ALL ELECTRICAL MATERIAL WORKMANSHIP SHALL CONFORM TO THE NATIONAL ELECTRIC CODE, LATEST EDITION, AND ALL APPLICABLE STATE AND LOCAL CODES.
- 12) THE EXACT LOCATION OF NEW UTILITY SERVICES AND CONNECTIONS SHALL BE COORDINATED WITH BUILDING DRAWINGS AND UTILITY COMPANIES.
- 13) ADJUST ALL MANHOLES, CATCH BASINS, CURB BOXES, ETC. WITHIN LIMITS OF WORK TO FINISH GRADE.
- 14) ALL UNDERGROUND CONDUITS SHALL HAVE NYLON PULL ROPES TO FACILITATE PULLING CABLES.
- 15) THE CONTRACTOR SHALL OBTAIN, PAY FOR, AND COMPLY WITH ALL REQUIRED PERMITS, ARRANGE FOR ALL INSPECTIONS, AND SUBMIT COPIES OF ACCEPTANCE CERTIFICATED TO THE OWNER PRIOR TO THE COMPLETION OF PROJECT.
- 16) THE CONTRACTOR SHALL PROVIDE AND INSTALL ALL MANHOLES, BOXES, FITTINGS, CONNECTORS, COVER PLATES AND OTHER MISCELLANEOUS ITEMS NOT NECESSARILY DETAILED IN THESE DRAWING TO RENDER INSTALLATION OF UTILITIES COMPLETE AND OPERATIONAL.
- 17) CONTRACTOR SHALL PROVIDE EXCAVATION, BEDDING, BACKFILL AND COMPACTION FOR NATURAL GAS SERVICES.
- 18) A 10-FOOT MINIMUM EDGE TO EDGE HORIZONTAL SEPARATION SHALL BE PROVIDED BETWEEN ALL WATER AND SANITARY SEWER LINES. AN 18-INCH MINIMUM OUTSIDE TO OUTSIDE VERTICAL SEPARATION SHALL BE PROVIDED AT ALL WATER/SANITARY SEWER CROSSINGS WATER ABOVE SEWER.
- 19) SAWCUT AND REMOVE PAVEMENT AND CONSTRUCT PAVEMENT TRENCH PATCH FOR ALL PROPOSED UTILITIES LOCATED IN EXISTING PAVEMENT AREAS TO REMAIN.
- 20) GATE VALVES, FITTINGS, ETC. SHALL MEET THE REQUIREMENTS OF THE CITY OF PORTSMOUTH.
- 21) COORDINATE TESTING OF SEWER CONSTRUCTION WITH THE CITY OF PORTSMOUTH.
- 22) ALL SEWER PIPES WITH LESS THAN 6' COVER SHALL BE INSULATED.

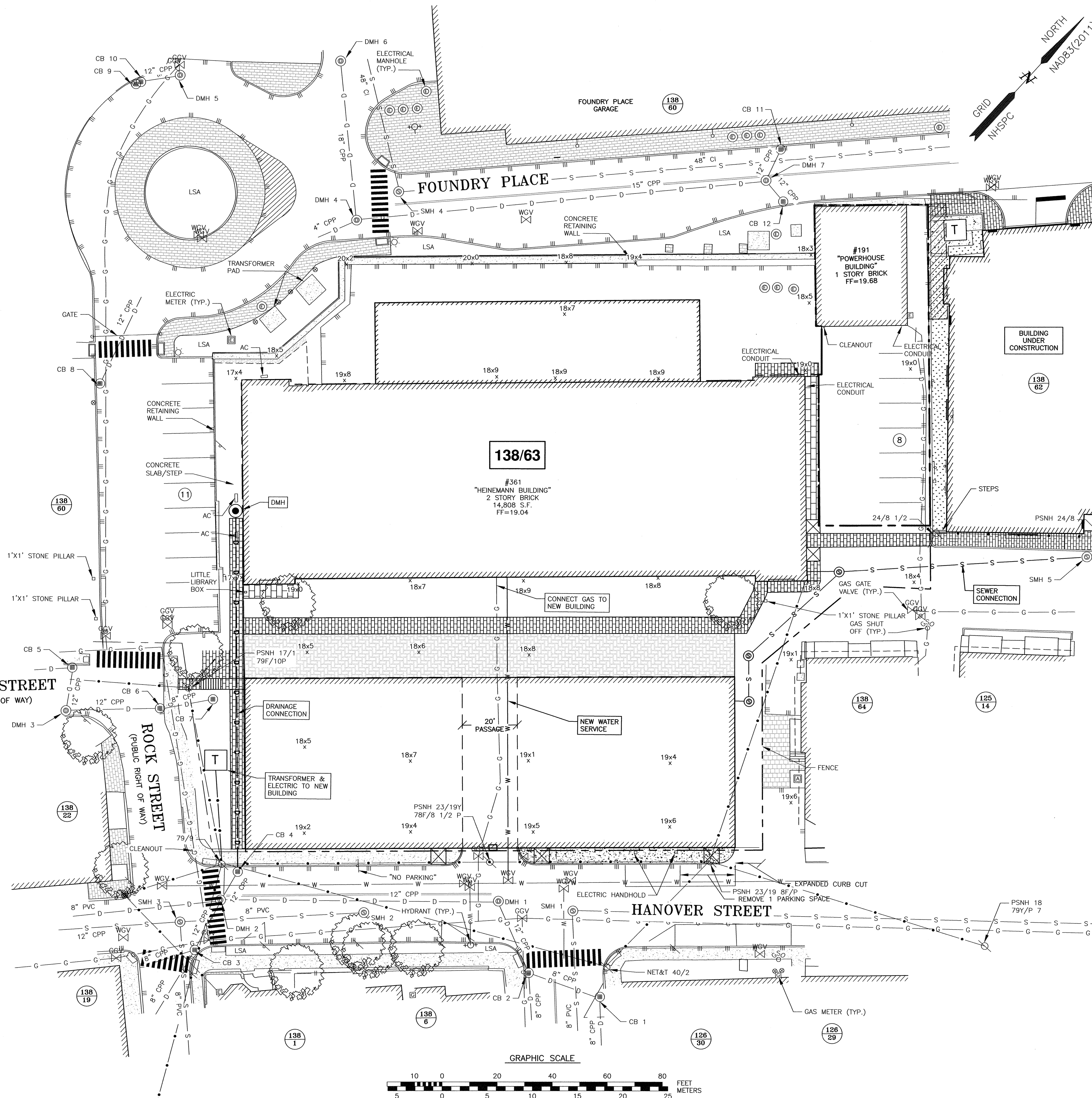

- NOTES:**
- 1) THE CONTRACTOR SHALL NOTIFY DIG SAFE AT 1-888-DIG-SAFE (1-888-344-7233) AT LEAST 72 HOURS PRIOR TO COMMENCING ANY EXCAVATION ON PUBLIC OR PRIVATE PROPERTY.
 - 2) UNDERGROUND UTILITY LOCATIONS ARE BASED UPON BEST AVAILABLE EVIDENCE AND ARE NOT FIELD VERIFIED. LOCATING AND PROTECTING ANY ABOVEGROUND OR UNDERGROUND UTILITIES IS THE SOLE RESPONSIBILITY OF THE CONTRACTOR AND/OR THE OWNER. UTILITY CONFLICTS SHOULD BE REPORTED AT ONCE TO THE DESIGN ENGINEER.
 - 3) CONTRACTOR SHALL INSTALL AND MAINTAIN EROSION CONTROL MEASURES IN ACCORDANCE WITH THE "NEW HAMPSHIRE STORMWATER MANUAL, VOLUME 3, EROSION AND SEDIMENT CONTROLS DURING CONSTRUCTION." (NHDES DECEMBER 2008).
 - 4) INSTALL CATCH BASIN INLET PROTECTION ON ALL EXISTING AND PROPOSED CATCH BASINS (IN THE PROJECT VICINITY) UNTIL CONSTRUCTION IS COMPLETED AND THE SITE IS STABILIZED.
 - 5) ALL WATER MAIN AND SANITARY SEWER WORK SHALL MEET THE STANDARDS OF THE NEW HAMPSHIRE STATE PLUMBING CODE AND CITY OF PORTSMOUTH DEPARTMENT OF PUBLIC WORKS.
 - 6) UTILITY AS-BUILTS SHALL BE SUBMITTED TO THE CITY OF PORTSMOUTH DEPARTMENT OF PUBLIC WORKS UPON COMPLETION OF THE PROJECT.
 - 7) EVERSOURCE WORK ORDER #XXXXXXX
 - 8) PROPOSED SEWER FLOW:
 36 UNITS X 170 GPD/UNITS = 6,120 GPD
 TOTAL FLOW: 6,120 GPD
 COMMERCIAL TBD S.F. 5 GPD/100 SF = TBD GPD
 - 9) THE APPLICANT SHALL HAVE A COMMUNICATIONS SITE SURVEY CONDUCTED BY A MOTOROLA COMMUNICATIONS CARRIER APPROVED BY THE PORTSMOUTH'S COMMUNICATIONS DIVISION. THE RADIO COMMUNICATIONS CARRIER MUST BE FAMILIAR AND CONVERSANT WITH THE PORTSMOUTH POLICE AND FIRE RADIO SYSTEMS CONFIGURATION. IF THE SITE SURVEY INDICATES THAT IT IS NECESSARY TO INSTALL A SIGNAL REPEATER EITHER ON OR NEAR THE PROPOSED PROJECT, THOSE COSTS SHALL BE THE RESPONSIBILITY OF THE PROPERTY OWNER. THE PROPERTY OWNER WILL BE REQUIRED TO MAINTAIN ANY INSTALLED EQUIPMENT. THE PROPERTY OWNER SHALL BE RESPONSIBLE TO PAY FOR THE SITE SURVEY WHETHER OR NOT THE SURVEY INDICATES THAT EQUIPMENT IS NECESSARY. THE OWNER SHALL COORDINATE WITH THE SUPERVISOR OF RADIO COMMUNICATIONS FOR PORTSMOUTH. THE SURVEY SHALL BE COMPLETED AND ANY REQUIRED EQUIPMENT INSTALLED, TESTED, AND ACCEPTED PRIOR TO THE ISSUANCE OF A CERTIFICATE OF OCCUPANCY.
 - 10) FINAL CONDUIT LOCATION SUBJECT TO CONFIRMATION FROM UTILITY PROVIDERS.
 - 11) EXISTING UTILITIES TO BE ABANDONED SHALL BE REMOVED TO THE UTILITY MAIN AND CAPPED PER THE UTILITY COMPANY REQUIREMENT.

**SITE REDEVELOPMENT
 361 HANOVER STREET
 PORTSMOUTH, N.H.**

0	ISSUED FOR COMMENT	4/3/24
NO.	DESCRIPTION	DATE
REVISIONS		

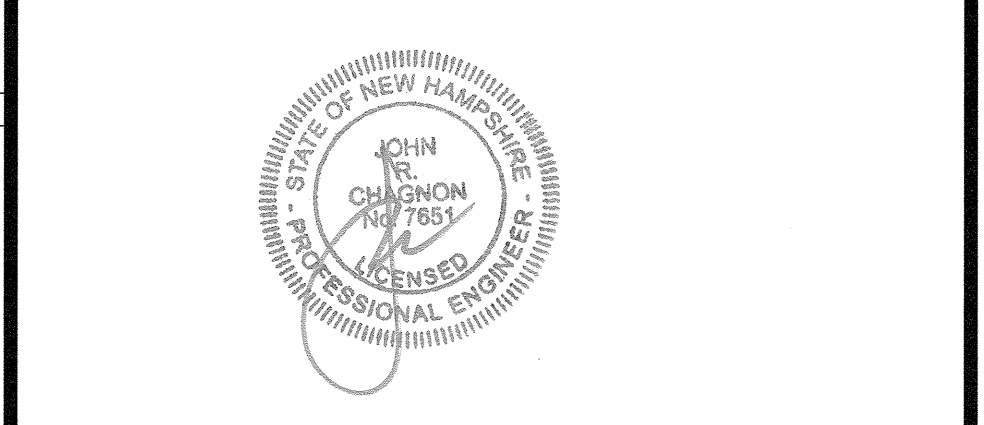

SCALE: 1"=20' JANUARY 2024

UTILITY PLAN **C4**

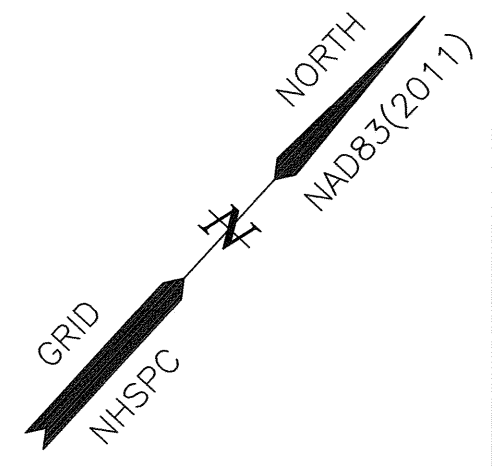

R7-8a
 12" x 18"
 SIGN ON POST

EACH SPACE
 SHALL HAVE
 THIS SIGN
 DISPLAYED PER
 ADA CODE

SIGNAGE

LEGEND SYMBOL

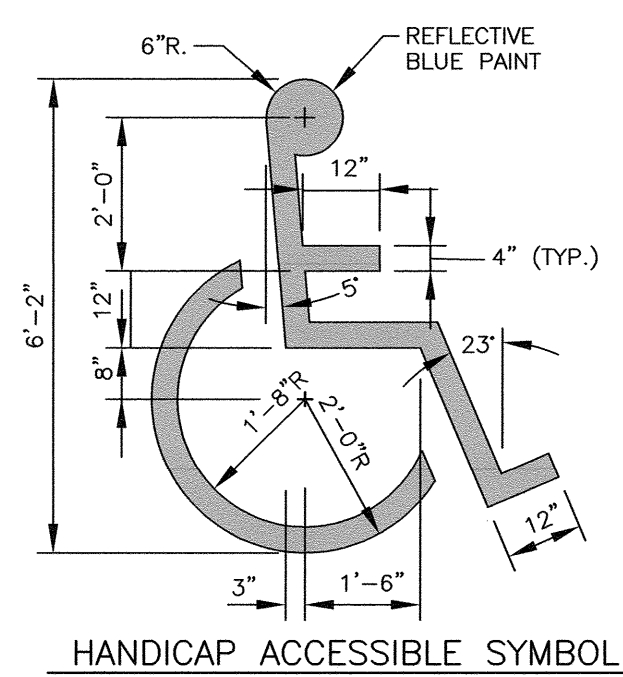

HANDICAP ACCESSIBLE SYMBOL



K-4438
 12" x 18"
 SIGN ON POST

SIGNAGE

HANDICAP ACCESS AISLE
 NO PARKING SIGN

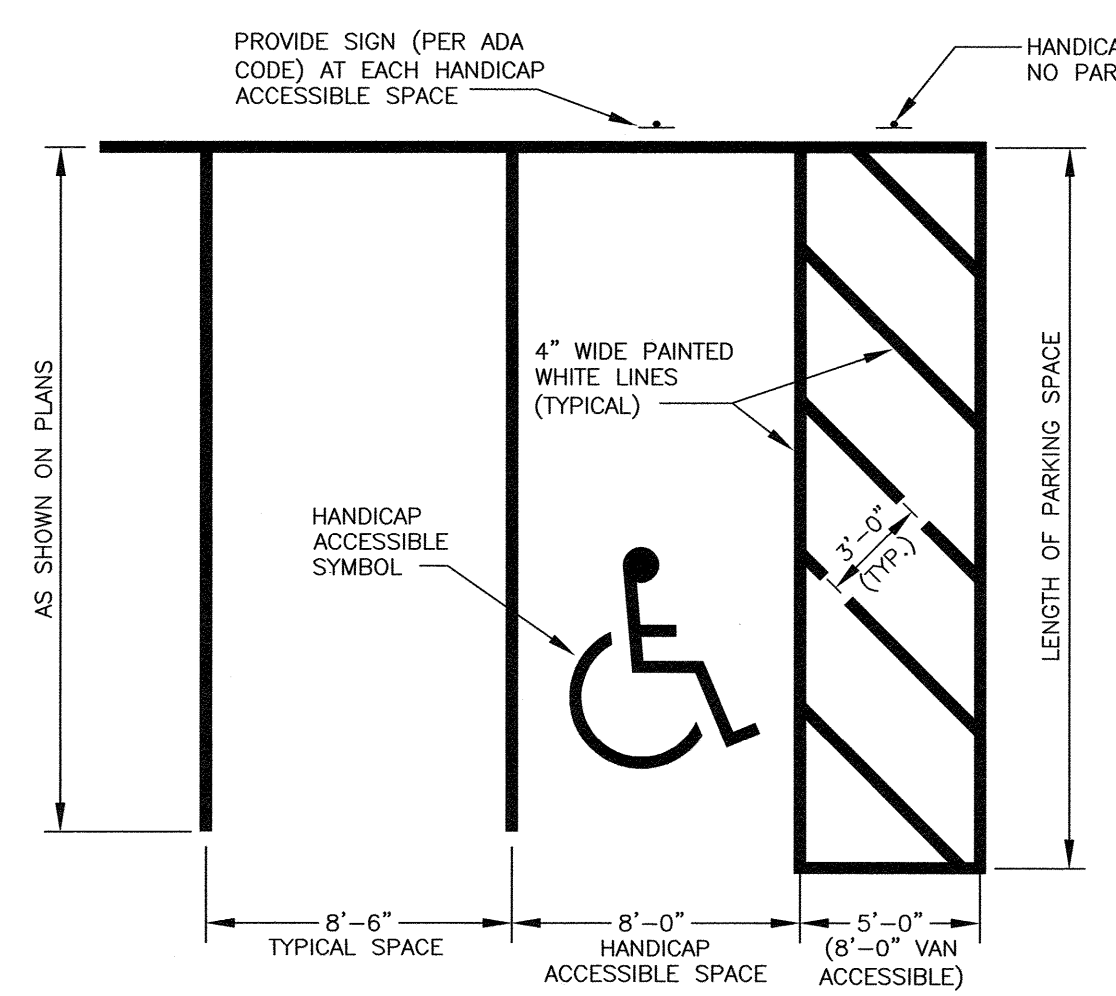

NOTES:

- 1) SYMBOL TO BE PAINTED IN ALL HANDICAPPED SPACES.
- 2) SYMBOL, PAINT AND SIGNAGE TO CONFORM TO AMERICANS WITH DISABILITIES ACT (ADA).
- 3) ALL VAN ACCESSIBLE SPACES SHALL HAVE "VAN ACCESSIBLE" PLATE INSTALLED ON SIGN POST BELOW HANDICAP SIGN.

1 HANDICAP PARKING DETAIL
 C5 NTS

PARKING ASSIGNMENT
 24 STACKED SPACES
 WILL BE ASSIGNED TO
 SPECIFIC UNITS
 18 SINGLE SPACES
 WILL BE ASSIGNED TO
 SPECIFIC UNITS
 6 GUEST SPACES WILL
 NOT BE ASSIGNED

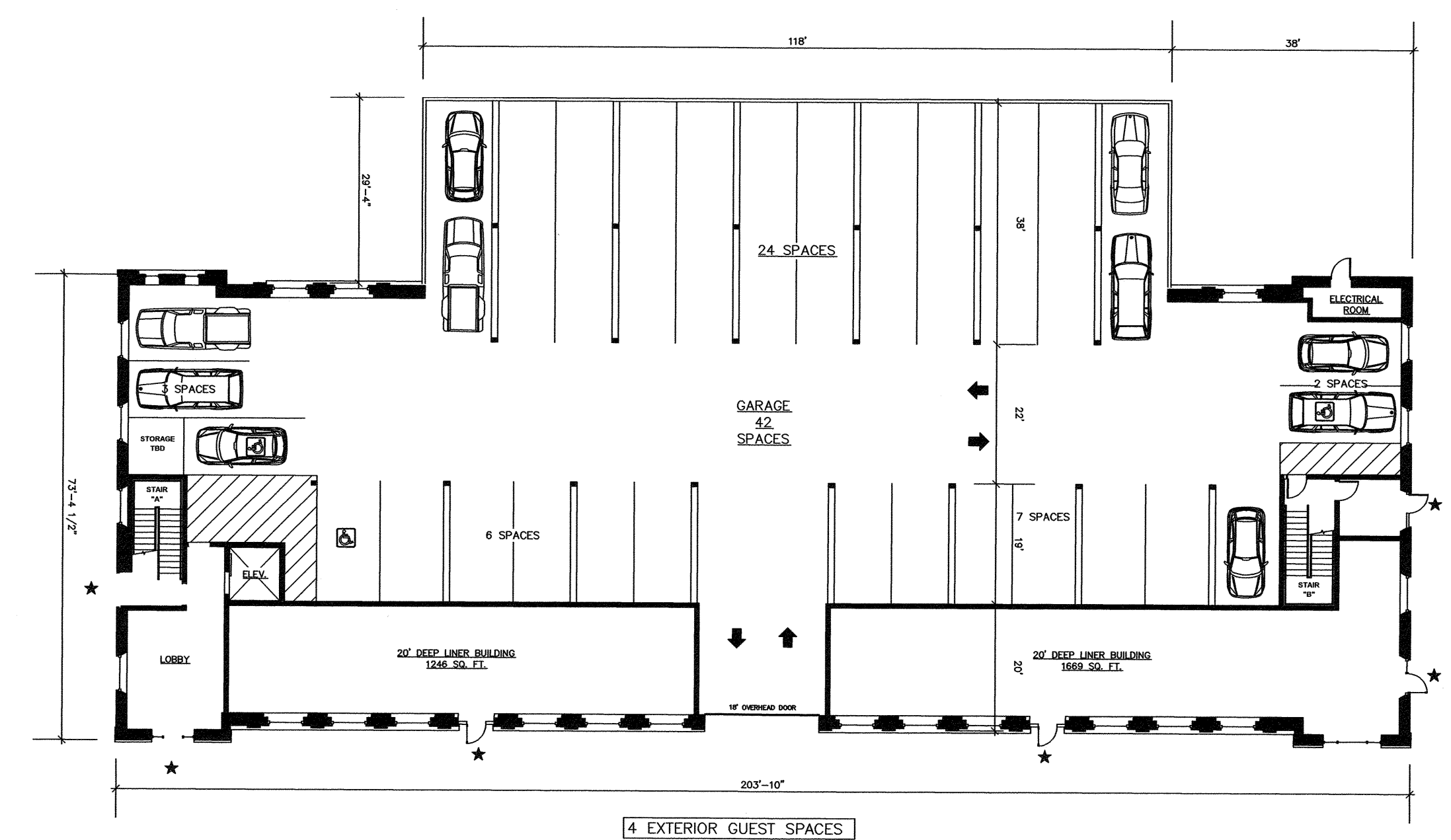

4 EXTERIOR GUEST SPACES

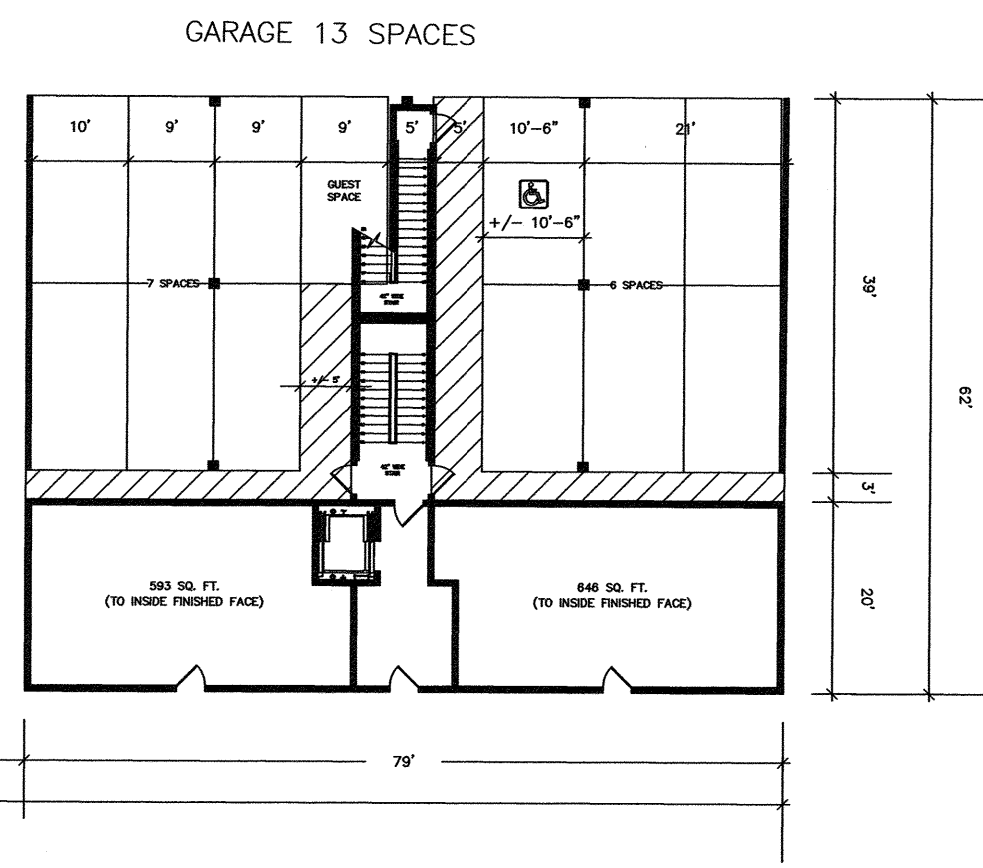
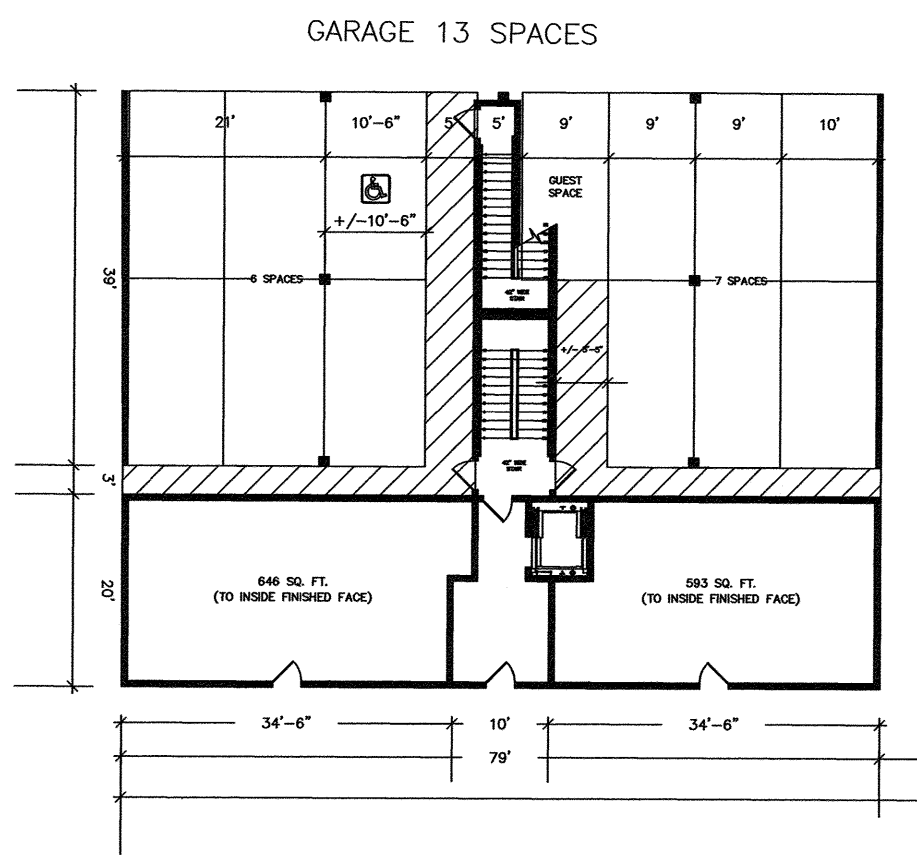

APPROVED BY THE PORTSMOUTH PLANNING BOARD

CHAIRMAN _____ DATE _____

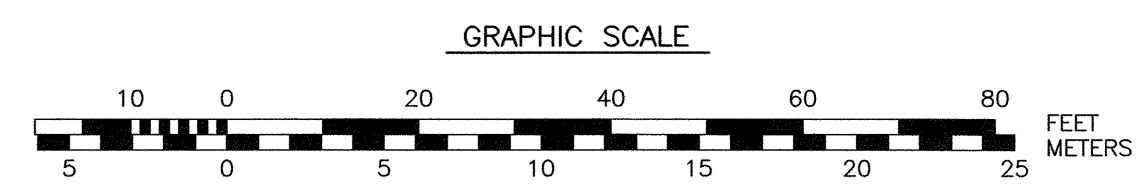

**SITE REDEVELOPMENT
 361 HANOVER STREET
 PORTSMOUTH, N.H.**

NO.	DESCRIPTION	DATE
0	ISSUED FOR COMMENT	4/3/24

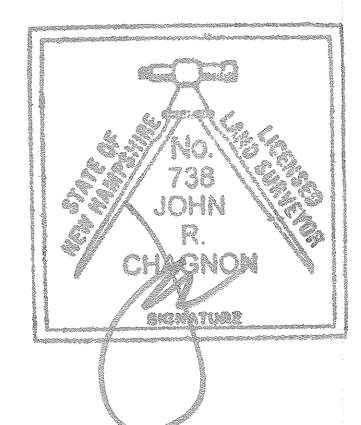

SCALE: 1"=20' JANUARY 2024

PARKING PLAN **C5**

361 HANOVER STREET
PORTSMOUTH, NH 03801



3 WEST (LEFT SIDE) ELEVATION
Scale: 1/8" = 1'-0"



2 EAST (RIGHT SIDE) ELEVATION
Scale: 1/8" = 1'-0"



1 SOUTH (FRONT) ELEVATION
Scale: 1/8" = 1'-0"

REVISION & REISSUE NOTES

No.	Date	Notes

Project #	Project Manager	Date
2024-09	X.X.	4-2-24

Scale: AS NOTED

PROPOSED ELEVATIONS

A2.1

361 HANOVER STREET
PORTSMOUTH, NH 03801

REVISION & REISSUE NOTES

No.	Date	Notes

Project # 2024-09	Project Manager X.X.	Date 4-2-24
----------------------	-------------------------	----------------

Scale: AS NOTED

PROPOSED
ELEVATION

A2.2



1 NORTH (REAR) ELEVATION
Scale: 1/8" = 1'-0"

361 HANOVER STREET
PORTSMOUTH, NH 03801



1 SOUTH (FRONT) ELEVATION
Scale: 1/8" = 1'-0"

REVISION & REISSUE NOTES

No.	Date	Notes

Project # 2024-09	Project Manager X.X.	Date 4-2-24
----------------------	-------------------------	----------------

Scale: AS NOTED

**PROPOSED
ELEVATION
(RESIDENTIAL OPTION)**

A2.3

ADDITIONS/ALTERATIONS
 TO THE:
HEINEMANN BUILDING
 361 HANOVER STREET, PORTSMOUTH, NH 03801

REVISION & REISSUE NOTES

No.	Date	Notes

Project #	Project Manager	Date
2024-09	X.X.	04.02.2024

Scale: AS NOTED

PROPOSED
 ELEVATIONS

A2.4

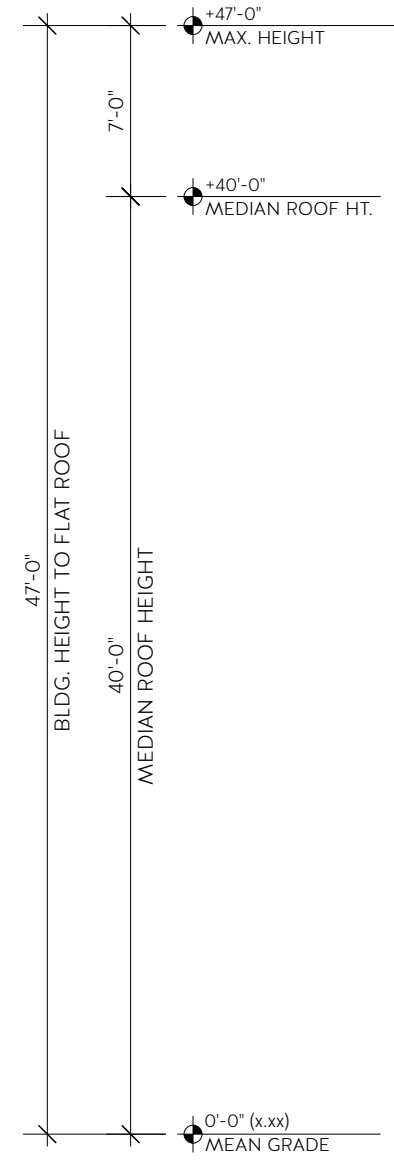

2 WEST ELEVATION
 Scale: 1/8" = 1'-0"



1 SOUTH ELEVATION (COMMERCIAL FIRST FLOOR)
 Scale: 1/8" = 1'-0"

ADDITIONS/ALTERATIONS
TO THE:
HEINEMANN BUILDING
361 HANOVER STREET, PORTSMOUTH, NH 03801



2 NORTH ELEVATION
Scale: 1/8" = 1'-0"

REVISION & REISSUE NOTES

No.	Date	Notes

Project #	Project Manager	Date
2024-09	X.X.	04.02.2024

Scale: AS NOTED

PROPOSED ELEVATIONS

A2.5

COPYRIGHT 2024 SCOTT M. BROWN, ARCHITECTS LLC

361 HANOVER STREET
 PORTSMOUTH, NH 03801

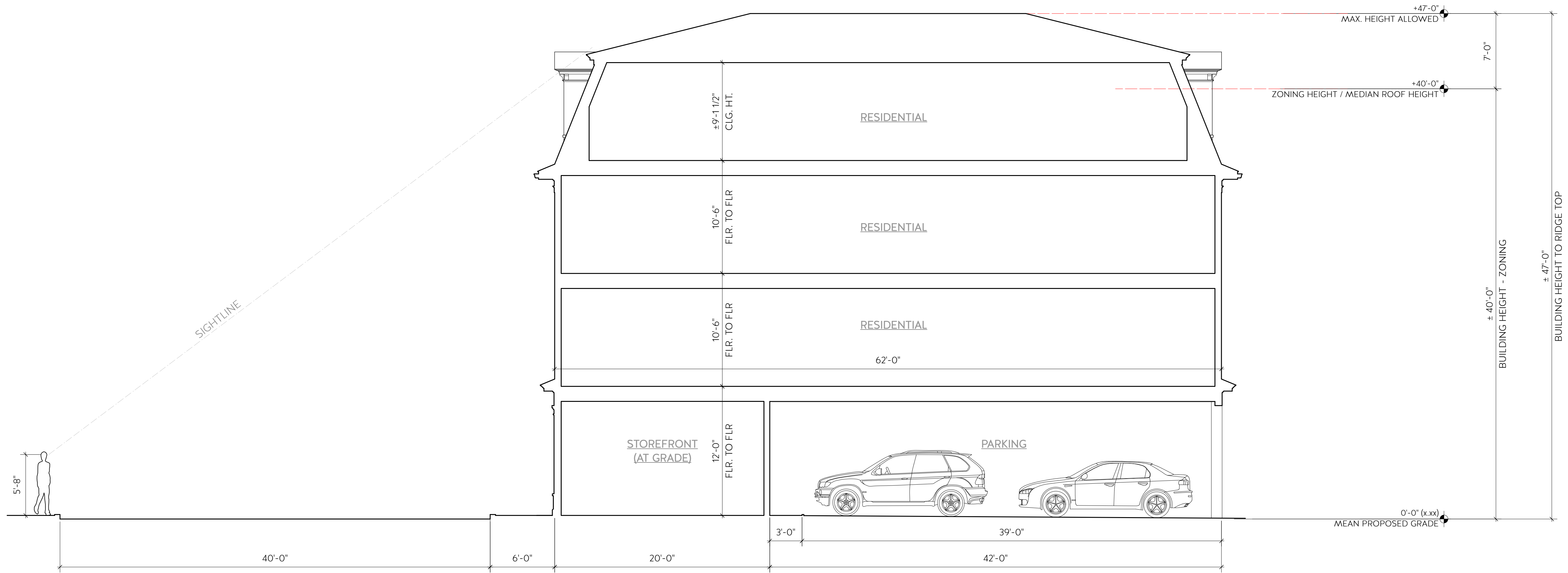

MANSARD WITH
 GROUND FLOOR COMMERCIAL

REVISION & REISSUE NOTES

No.	Date	Notes

Project #	Project Manager	Date
2024-09	X.X.	4-2-24

Scale: 3/16" = 1'-0"

CONCEPTUAL
 BUILDING SECTION

A3.1