

LETTER OF AGENDA

We respectfully submit this Application for Approval.

At this time, the team is focusing on the remaining structures located behind the Annex.

We have included the following items for your consideration:

CJ Architects – Proposed Design

- 1.0 Existing Elevations Scope of Work
- 2.0 Proposed Details
- 3.0 Historic Stone Precedents & Stone Chimney Visibility
- 4.0 Proposed Renderings
- 5.0 Proposed Materials
- 6.0 Proposed Elevations and Plans

Appendix-

1. Historic Precedents
2. Existing Conditions Documentation of the Three Primary Structures
3. Pedestrian Views of Site
4. Property Timeline
5. Historic Consultants
6. Gorham Structural Engineering – Existing Structural Report
7. David Calkins GC & GM – Existing Conditions Evaluation

The current HDC Approval was granted to the prior owner and amended to include a revised scope for the Mansion and Annex.

Thank you for your consideration.
Sincerely,



Carla Goodknight, AIA, NCARB
Principal, CJ Architects

179 PLEASANT STREET
PORTSMOUTH, NEW HAMPSHIRE



AERIAL VIEW

HDC APPLICATION TO AMEND PREVIOUS APPROVAL: SEPTEMBER 7, 2022



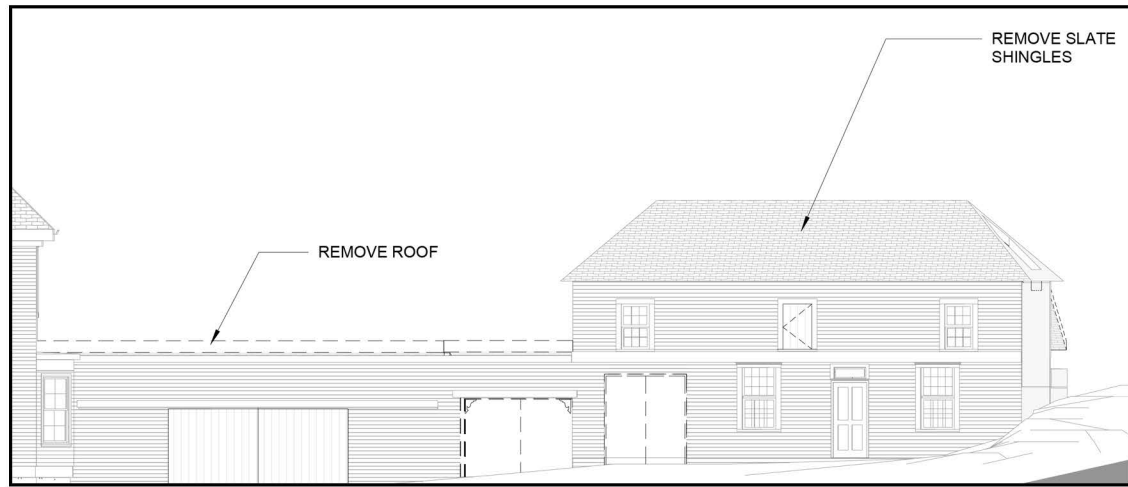

PREVIOUSLY APPROVED FRONT ELEVATION (FOR REFERENCE)



VIEW OF EXISTING FRONT ELEVATION



- KEY:
- TO BE REMOVED, RESTORED, & RE-INSTALLED
 - TO BE REPLACED IN KIND
 - TO BE DEMOLISHED



ORIGINAL HISTORIC DOORS TO BE REMOVED, RESTORED, AND REINSTALLED ON NEW CONNECTOR CONSTRUCTION

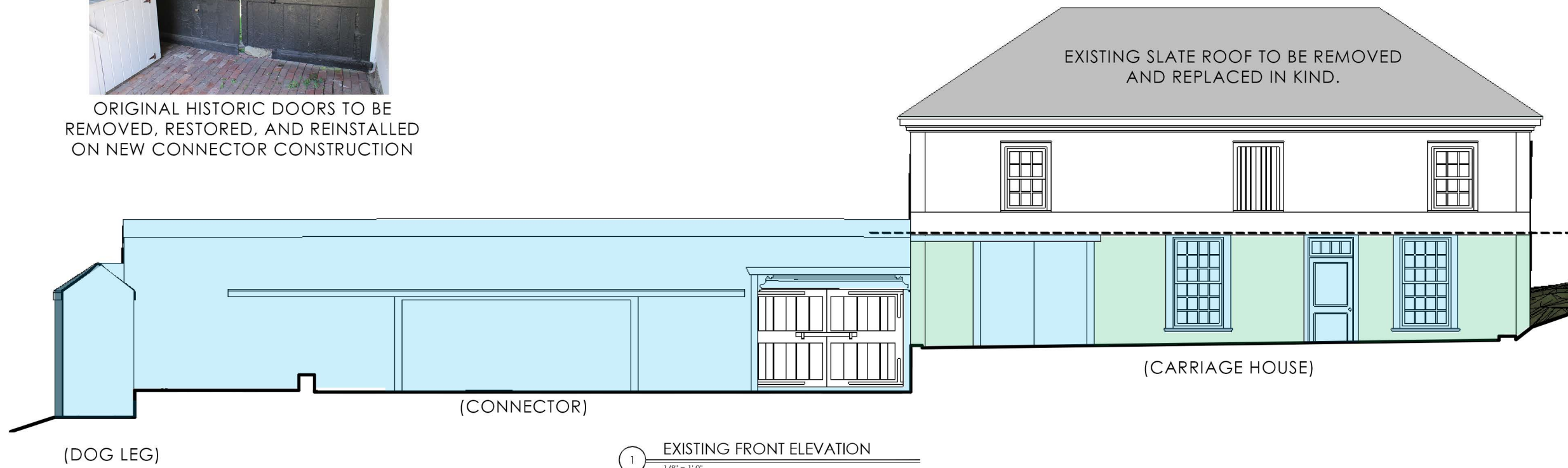

SECOND FLOOR STRUCTURE, WALLS, AND ROOF ABOVE TO BE PRESERVED AND RAISED IN ORDER TO CONSTRUCT NEW STABLE FIRST FLOOR FRAMING BELOW.

FIRST FLOOR FOUNDATION WILL BE INSTALLED 18" ABOVE ADJACENT GRADE AROUND PERIMETER TO MAINTAIN WATER TIGHT CONDITIONS.

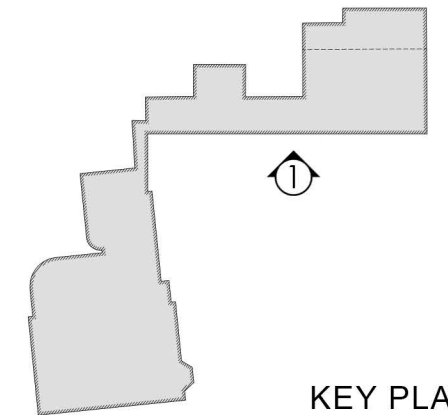

KEY PLAN

1 EXISTING FRONT ELEVATION
1/8" = 1'-0"

179 PLEASANT STREET
PORTSMOUTH, NEW HAMPSHIRE

SELECTIVE DEMOLITION, PRESERVATION, AND RESTORATION

FRONT ELEVATION

HDC APPLICATION TO AMEND PREVIOUS APPROVAL: SEPTEMBER 7, 2022



1.0

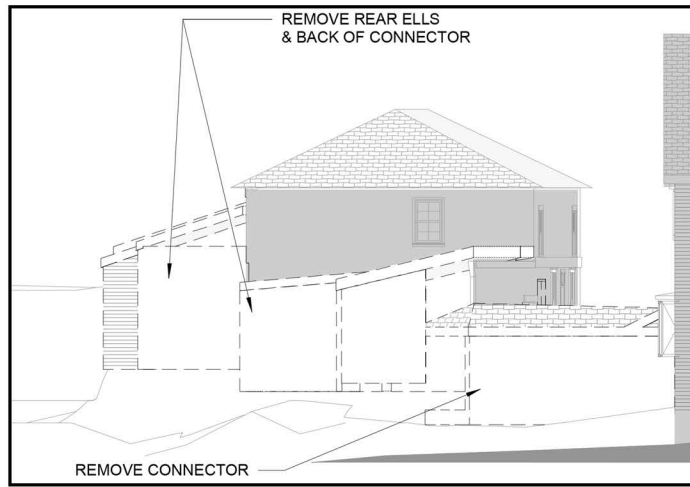

PREVIOUSLY APPROVED SIDE ELEVATION
(FOR REFERENCE)



VIEW OF EXISTING SIDE ELEVATION



KEY:

- TO BE REMOVED, RESTORED, & RE-INSTALLED
- TO BE REPLACED IN KIND
- TO BE DEMOLISHED

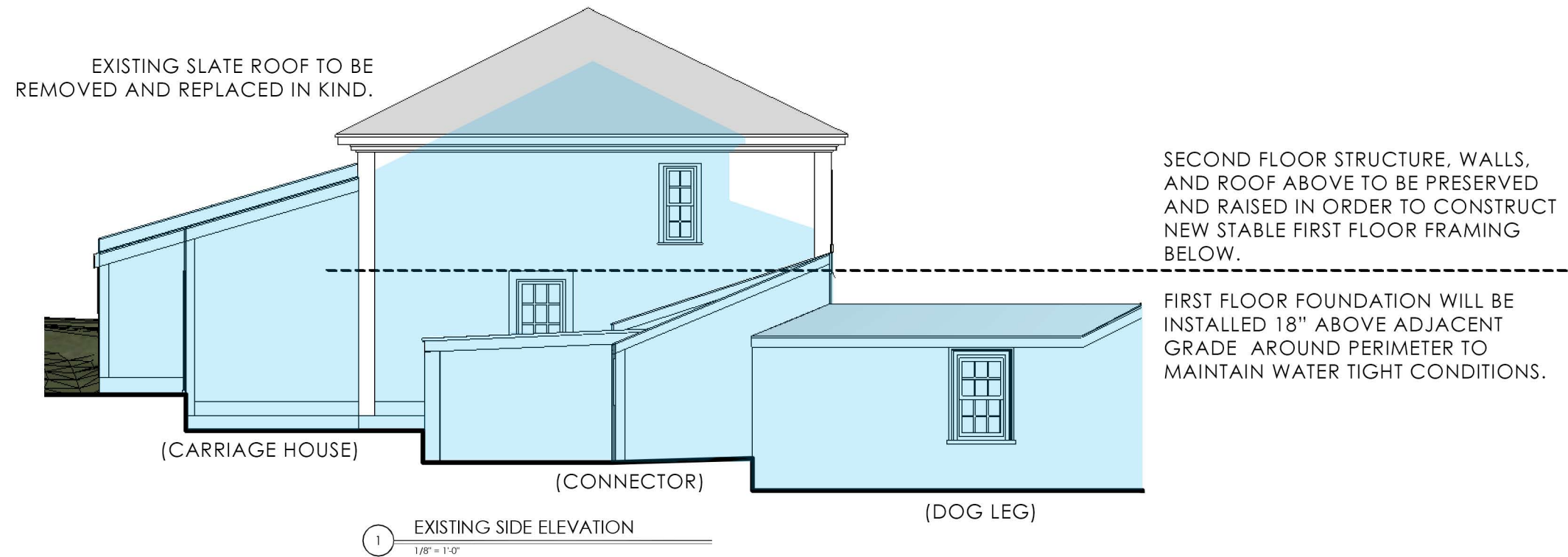

1 EXISTING SIDE ELEVATION
1/8" = 1'-0"

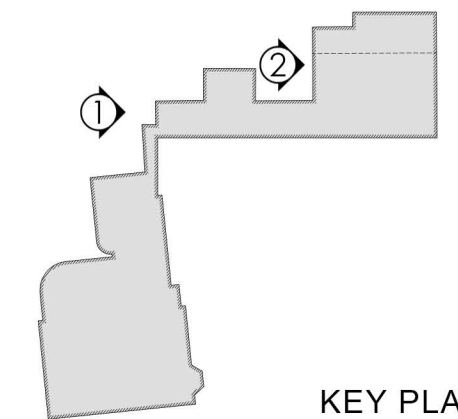

KEY PLAN

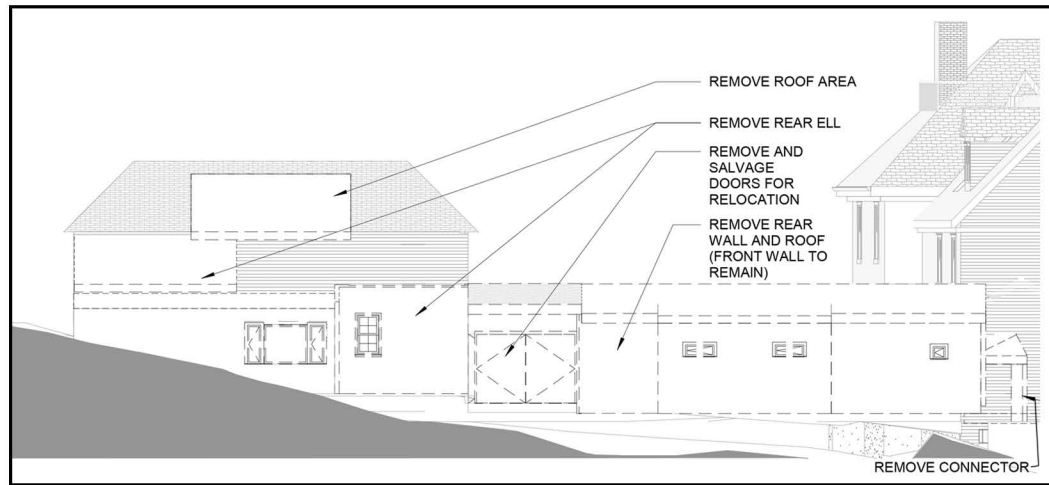

PREVIOUSLY APPROVED REAR ELEVATION (FOR REFERENCE)



VIEW OF EXISTING REAR ELEVATION



- KEY:
- TO BE REMOVED, RESTORED, & RE-INSTALLED
 - TO BE REPLACED IN KIND
 - TO BE DEMOLISHED

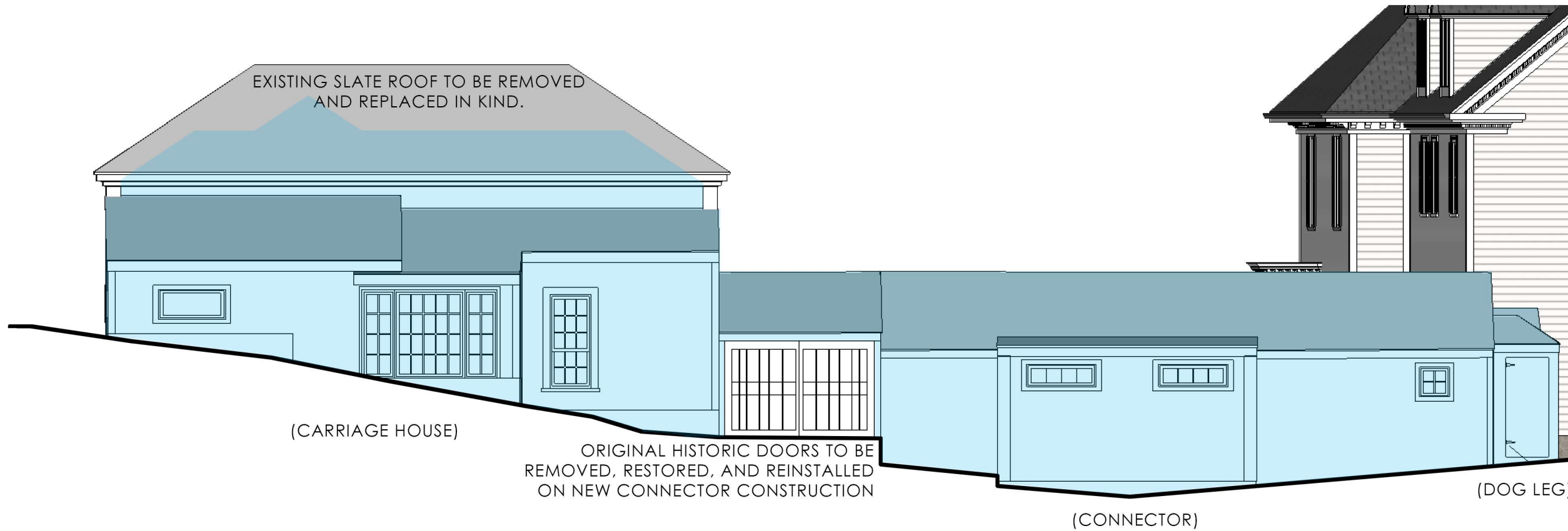

(CARRIAGE HOUSE)

ORIGINAL HISTORIC DOORS TO BE REMOVED, RESTORED, AND REINSTALLED ON NEW CONNECTOR CONSTRUCTION

(CONNECTOR)

(DOG LEG)

1 EXISTING REAR ELEVATION
1/8" = 1'-0"

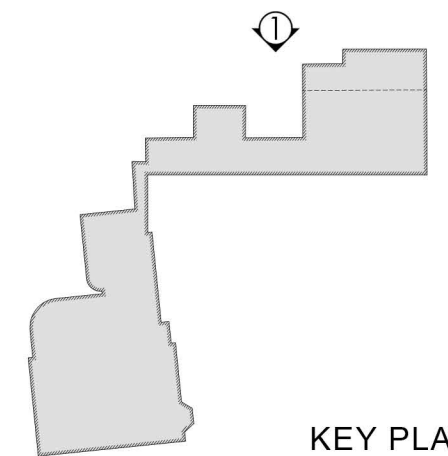

KEY PLAN

179 PLEASANT STREET
PORTSMOUTH, NEW HAMPSHIRE

SELECTIVE DEMOLITION, PRESERVATION, AND RESTORATION

REAR ELEVATION

HDC APPLICATION TO AMEND PREVIOUS APPROVAL: SEPTEMBER 7, 2022



1.2

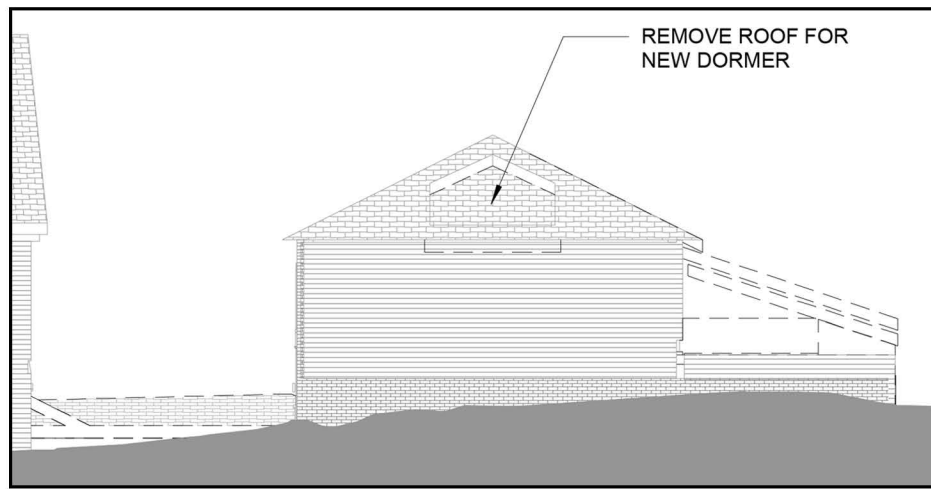

PREVIOUSLY APPROVED SIDE ELEVATION (FOR REFERENCE)



VIEW OF EXISTING SIDE ELEVATION

- KEY:
- TO BE REMOVED, RESTORED, & RE-INSTALLED
 - TO BE REPLACED IN KIND
 - TO BE DEMOLISHED

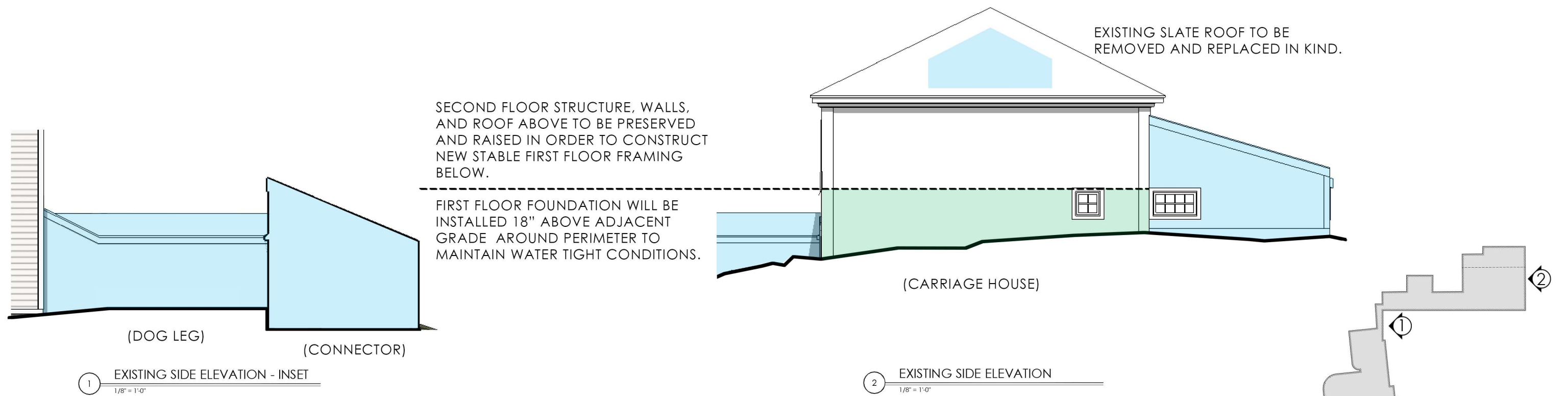

(DOG LEG)

(CONNECTOR)

(CARRIAGE HOUSE)

1 EXISTING SIDE ELEVATION - INSET
1/8" = 1'-0"

2 EXISTING SIDE ELEVATION
1/8" = 1'-0"

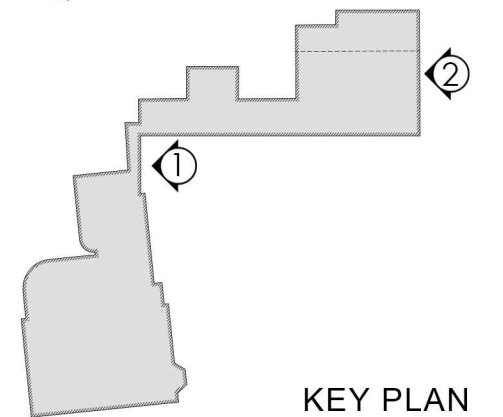

KEY PLAN

179 PLEASANT STREET
PORTSMOUTH, NEW HAMPSHIRE

SELECTIVE DEMOLITION, PRESERVATION, AND RESTORATION
SIDE ELEVATION
HDC APPLICATION TO AMEND PREVIOUS APPROVAL: SEPTEMBER 7, 2022



1.3

KEY

- CARRIAGE - WINDOW CASING
- CARRIAGE - CORNER BOARD & EAVE
- CARRIAGE - TRIM BOARD
- CARRIAGE - SKIRTBOARD
- ANNEX - WINDOW CASING
- ANNEX - ENTRY DOOR TRIM
- ANNEX - SKIRTBOARD
- SECOND FLOOR SHADED AREA OF THE CARRIAGE HOUSE AND ROOF TO BE RAISED AND PRESERVED



1 PROPOSED SIDE ELEVATION - INSET
1/16" = 1'-0"



2 PROPOSED SIDE ELEVATION - INSET
1/16" = 1'-0"



3 PROPOSED SIDE ELEVATION
1/16" = 1'-0"



4 PROPOSED SIDE ELEVATION - INSET
1/16" = 1'-0"

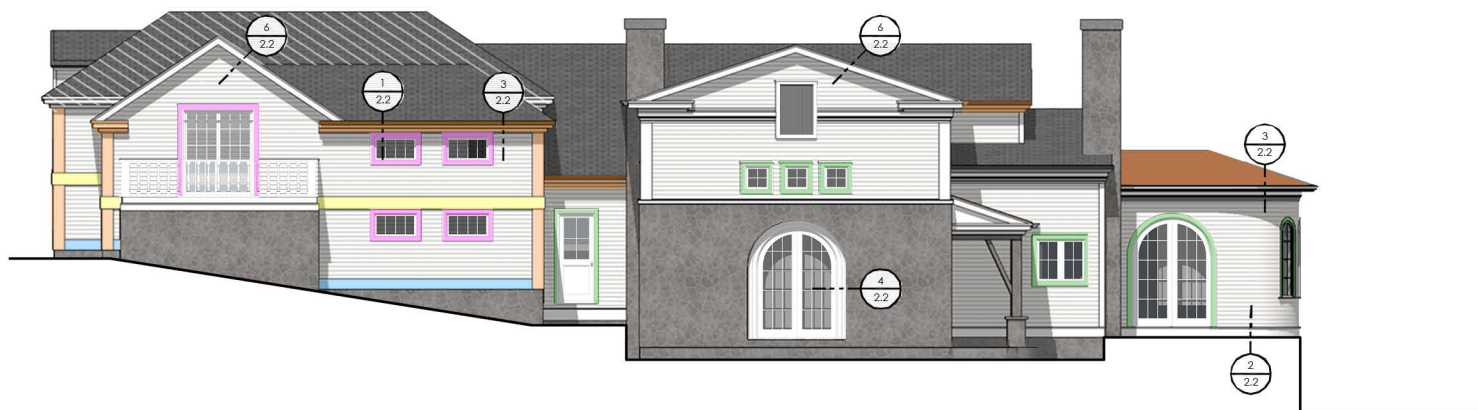

5 PROPOSED REAR ELEVATION
1/16" = 1'-0"



6 PROPOSED SIDE ELEVATION
1/16" = 1'-0"

179 PLEASANT STREET
PORTSMOUTH, NEW HAMPSHIRE

PROPOSED DETAIL KEYS

HDC APPLICATION TO AMEND PREVIOUS APPROVAL: SEPTEMBER 7, 2022



2.0

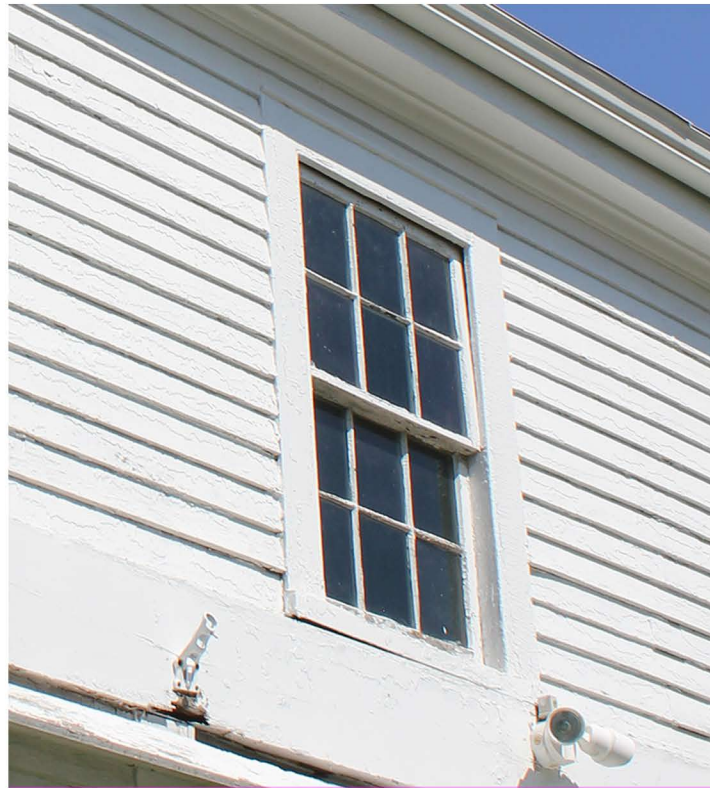

CARRIAGE HOUSE - WINDOW CASING



CARRIAGE HOUSE - CORNER BOARD & EAVE

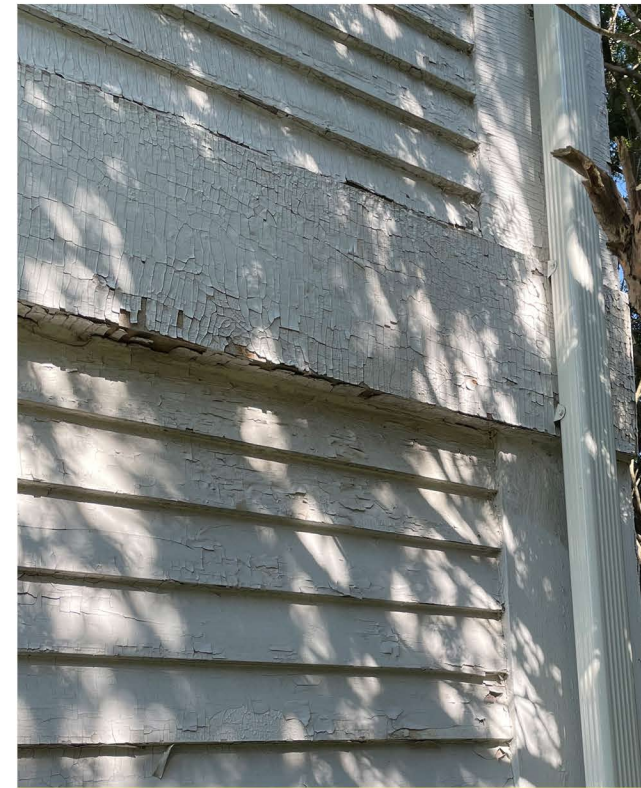

CARRIAGE HOUSE - TRIM BOARD

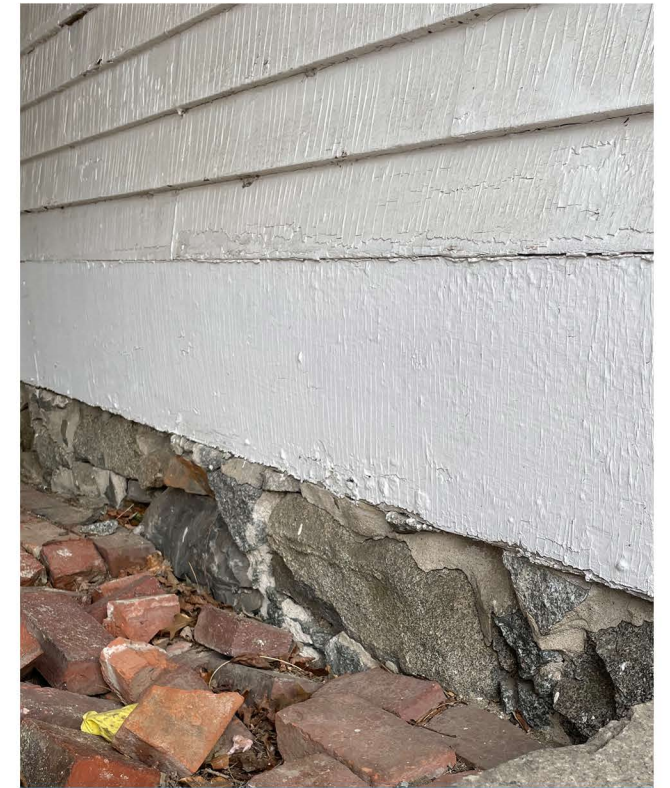

CARRIAGE HOUSE - SKIRTBOARD



ANNEX - WINDOW CASING



ANNEX - WINDOW TRIM

ANNEX - WINDOW SILL

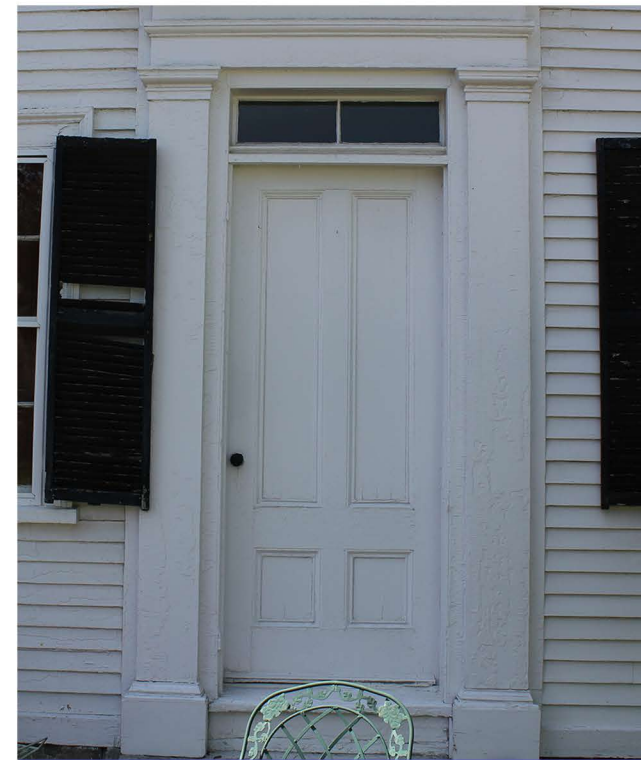

ANNEX - ENTRY DOOR TRIM



ANNEX - SKIRTBOARD

179 PLEASANT STREET
PORTSMOUTH, NEW HAMPSHIRE

PROPOSED DETAILS

HDC APPLICATION TO AMEND PREVIOUS APPROVAL: SEPTEMBER 7, 2022



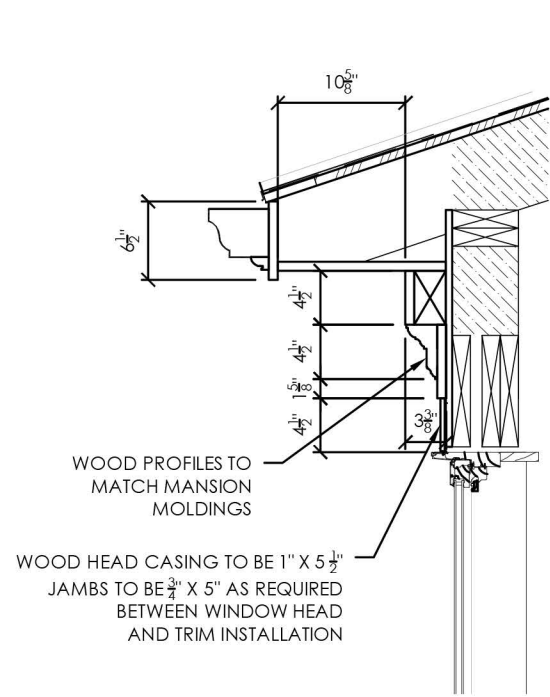

1 EAVE DETAIL AT WINDOW HEAD
3/4" = 1'-0"

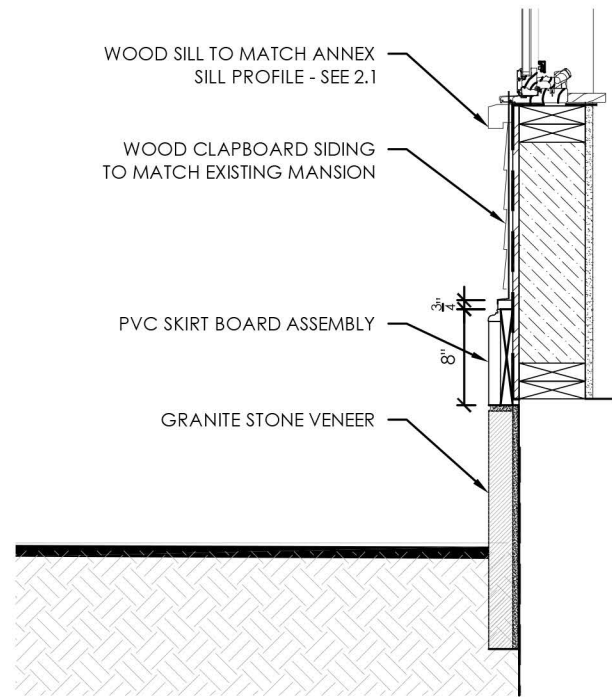

2 SKIRT BOARD
3/4" = 1'-0"

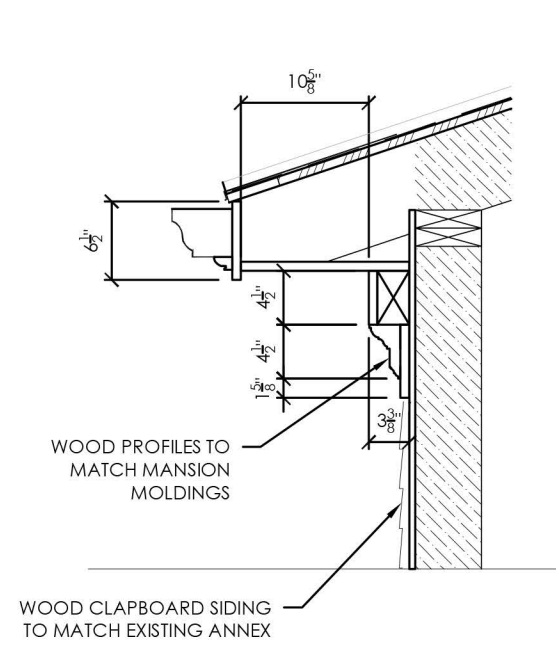

3 EAVE DETAIL
3/4" = 1'-0"

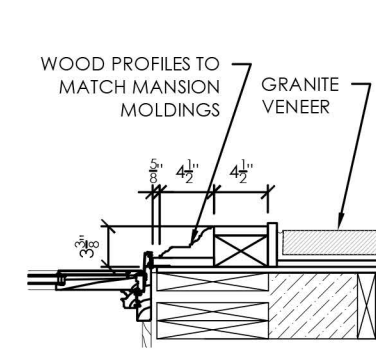

4 CASING
3/4" = 1'-0"

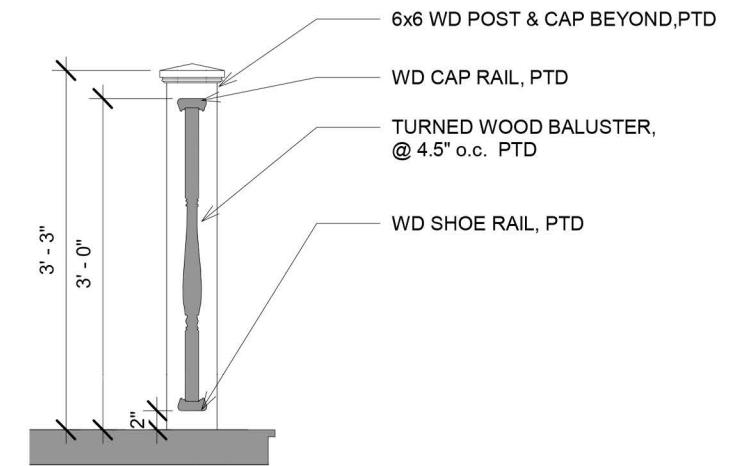

5 RAILING DETAIL
N.T.S.

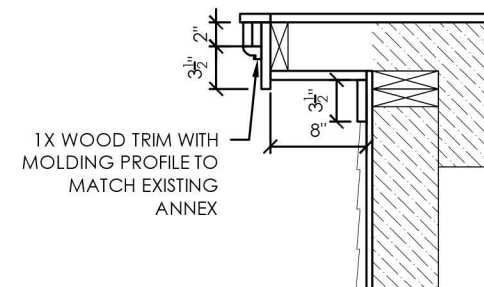

6 RAKE
3/4" = 1'-0"

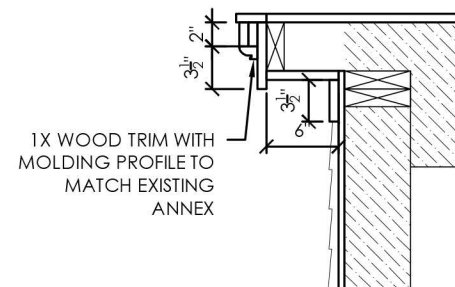

7 RAKE
3/4" = 1'-0"

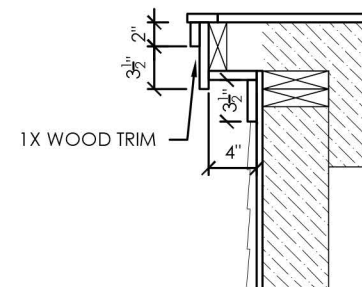

8 RAKE
3/4" = 1'-0"

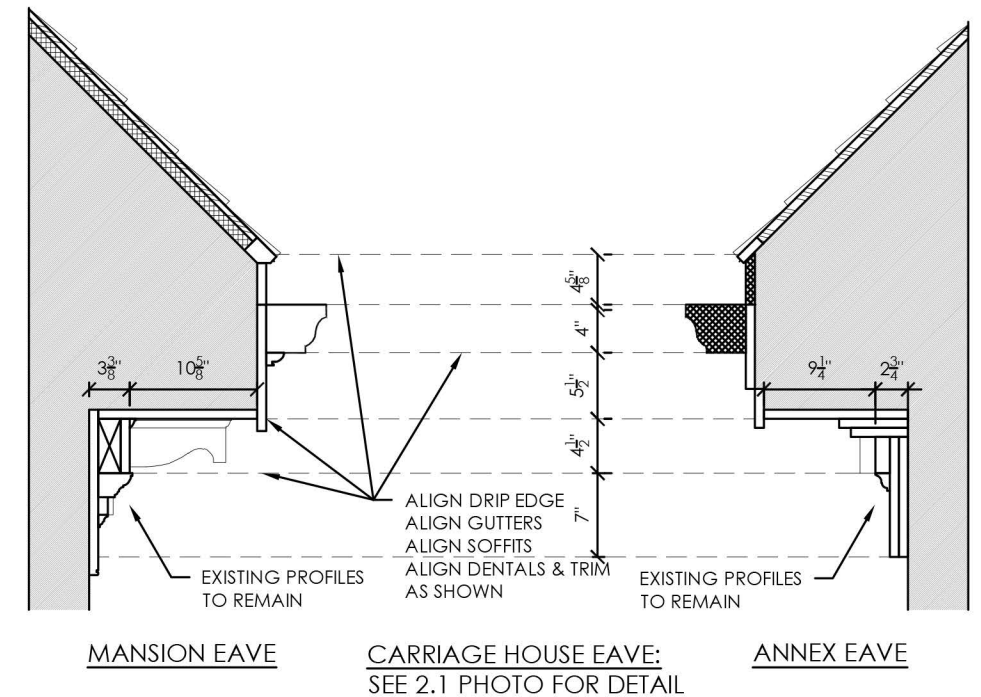

9 EAVE REFERENCE
3/4" = 1'-0"

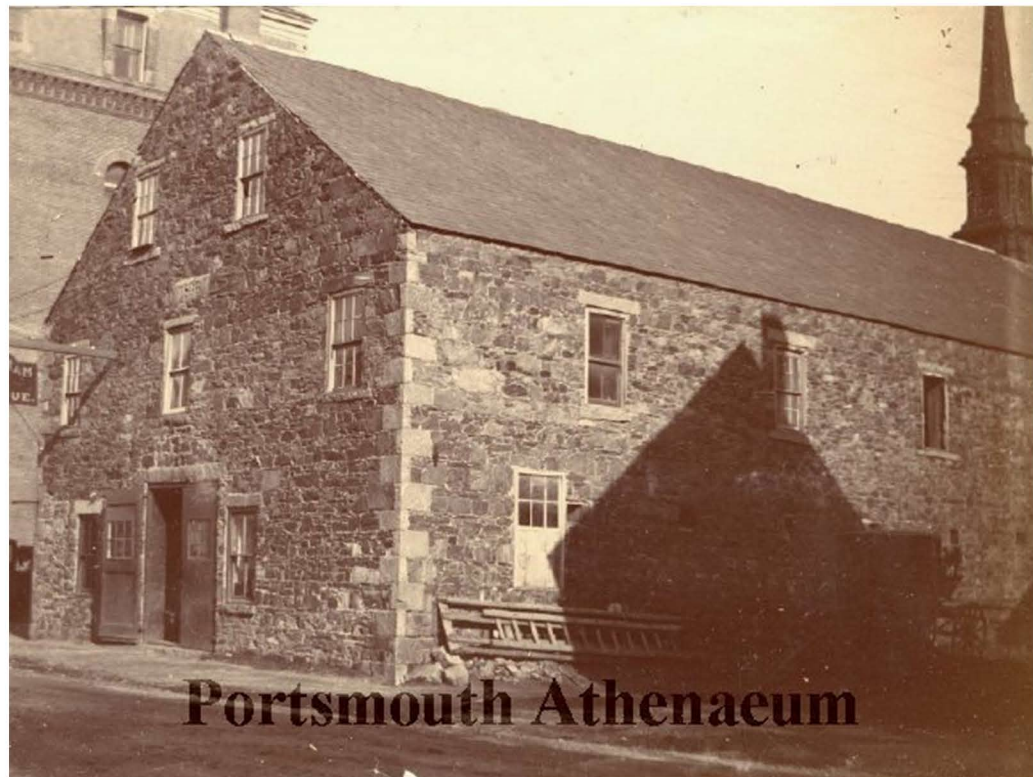

1. STONE STABLE (1836) - FLEET STREET, PORTSMOUTH NH



2. COTTAGES (1900's) - STAR ISLAND, RYE NH



PROPOSED STONE VENEER

THE SOIL CONDITIONS AT 179 PLEASANT STREET ARE ROCKY AND CONTAIN LEDGE OUTCROPPINGS.

PHOTO 5 BELOW DEPICTS THE STONE LIKELY FOUND DURING EXCAVATION FOR THE CONSTRUCTION OF THE CAPTAINS MANSION AT 179 PLEASANT STREET. PHOTO 6 SHOWS THE STONE FOUNDATION, CONSTRUCTED WITH SIMILAR STONE, UNCOVERED AT THE INTERSECTION OF THE ANNEX AND MANSION FOUNDATIONS.

THE PROPOSED STONE VENEER FOR USE ON THE NEW CONSTRUCTION HAS BEEN SELECTED TO MATCH THIS EXISTING STONE AS MUCH AS POSSIBLE.

THE STONE FOUND AT THIS LOCATION IS AKIN TO VARIOUS BUILDINGS USING STONE CONSTRUCTION IN THE SURROUNDING AREA. ALL OF WHICH WERE CONSTRUCTED DURING COMPARABLE HISTORICAL ERAS. SEE HISTORICAL REFERENCES TO THE LEFT COMPARED TO UNCOVERED STONE FROM 179 PLEASANT STREET EXCAVATION EFFORTS BELOW.



3. JABEZ FITCH HOUSE (1725) - 406 HIGH STREET, PORTSMOUTH NH

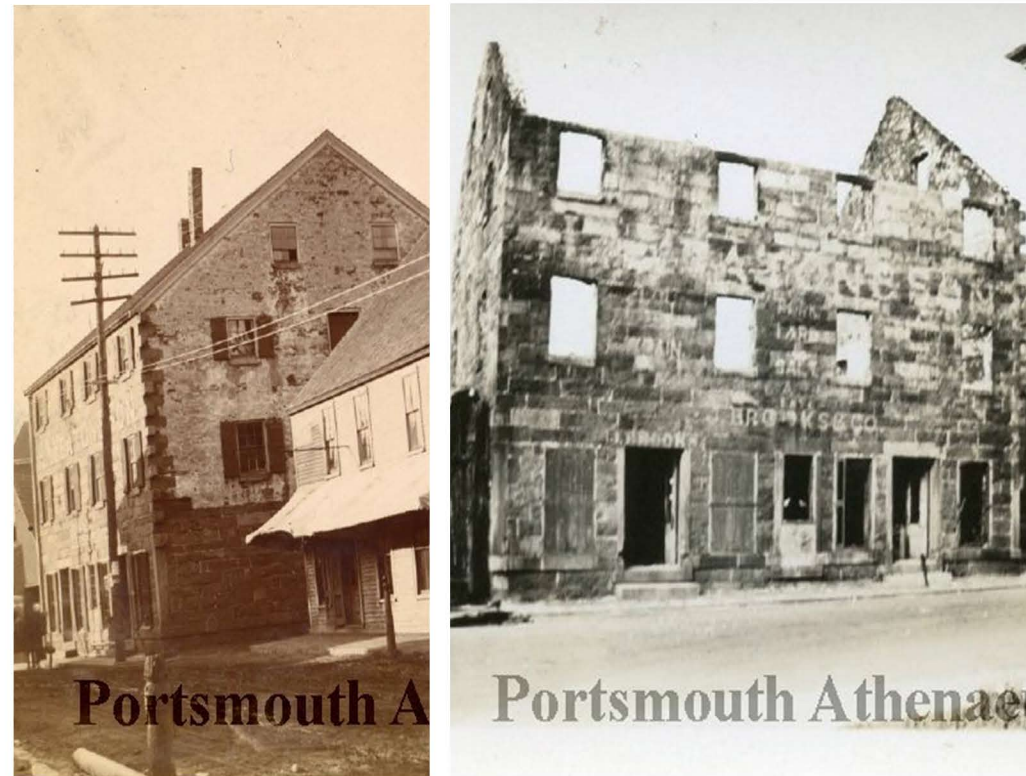

4. STONE STORE (1800's) - MARKET STREET, PORTSMOUTH NH

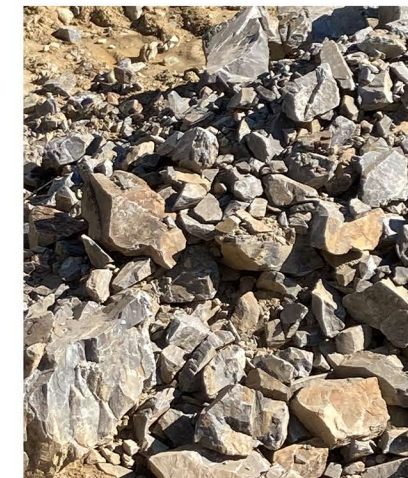

5. TYPICAL STONE UNCOVERED DURING EXCAVATION



6. EXISTING FOUNDATION AT MANSION

CHIMNEY #1 VISIBILITY FROM PLEASANT STREET SHOWN BELOW

CHIMNEY #2 NOT VISIBLE FROM PLEASANT STREET



1. CHIMNEY IS OBSCURED BY MANSION



2. CHIMNEY APPEARS BRIEFLY BETWEEN MANSION AND CONNECTOR



3. CHIMNEY IS PARTIALLY OBSCURED BY CONNECTOR



4. CHIMNEY IS MORE OBSCURED AND EVENTUALLY HIDDEN COMPLETELY

179 PLEASANT STREET
PORTSMOUTH, NEW HAMPSHIRE

VISIBILITY OF STONE CHIMNEY FROM PLEASANT STREET

HDC APPLICATION TO AMEND PREVIOUS APPROVAL: SEPTEMBER 7, 2022





179 PLEASANT STREET
PORTSMOUTH, NEW HAMPSHIRE

VIEW FROM PLEASANT STREET

HDC APPLICATION TO AMEND PREVIOUS APPROVAL: SEPTEMBER 7, 2022



4.0



179 PLEASANT STREET
PORTSMOUTH, NEW HAMPSHIRE

VIEW OF BACKYARD

HDC APPLICATION TO AMEND PREVIOUS APPROVAL: SEPTEMBER 7, 2022



4.1



179 PLEASANT STREET
PORTSMOUTH, NEW HAMPSHIRE

VIEW OF CARRIAGE HOUSE FROM BACKYARD

HDC APPLICATION TO AMEND PREVIOUS APPROVAL: SEPTEMBER 7, 2022





SLATE ROOFING

MANUFACTURER: CAMARA SLATE
SIZE: 12x18
COLOR: SPANISH BLACK

179 PLEASANT STREET
PORTSMOUTH, NEW HAMPSHIRE



PREVIOUSLY APPROVED ON MAIN HOUSE 3/2/22

FLAT SEAM COPPER ROOF

MANUFACTURER: CUSTOM FABRICATED
STYLE: FLAT SEAM
MATERIAL: COPPER

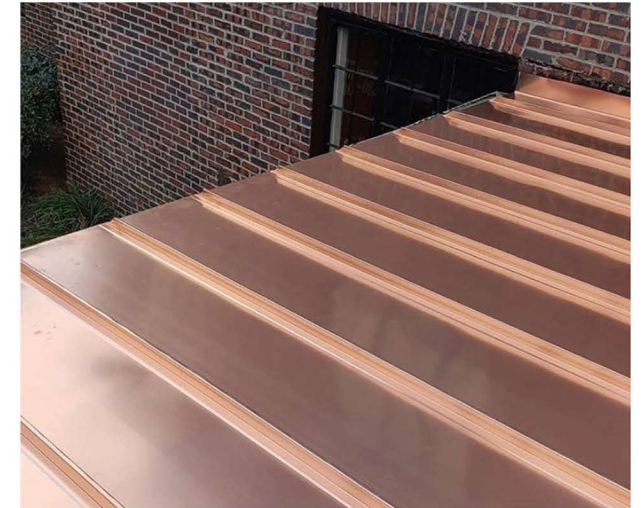

PREVIOUSLY APPROVED ON MAIN HOUSE 3/2/22

STANDING SEAM COPPER ROOF

MANUFACTURER: CUSTOM FABRICATED
STYLE: STANDING SEAM
MATERIAL: COPPER

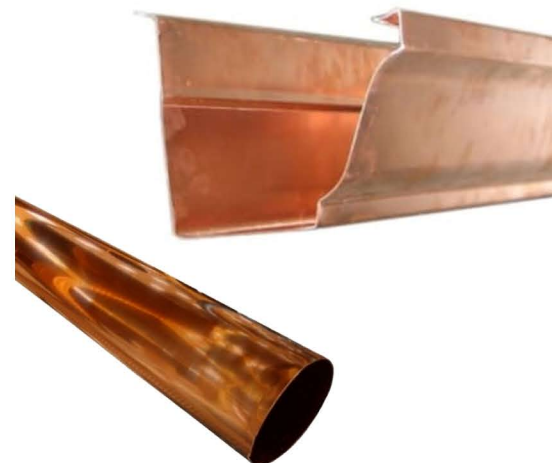

PREVIOUSLY APPROVED ON MAIN HOUSE 3/2/22

GUTTER & DOWNSPOUT

MANUFACTURER: CUSTOM FABRICATED
STYLE: K-STYLE GUTTER W/ 3" SMOOTH DOWNSPOUT
MATERIAL: COPPER



STONE VENEER

MANUFACTURER: CUSTOM
STYLE: CUT GRANITE; THERMAL FINISH
COLOR: GRAY

PROPOSED MATERIALS

HDC APPLICATION TO AMEND PREVIOUS APPROVAL: SEPTEMBER 7, 2022



5.0



SLIDER

MANUFACTURER: MARVIN
STYLE: ULTIMATE
MATERIAL: CLAD

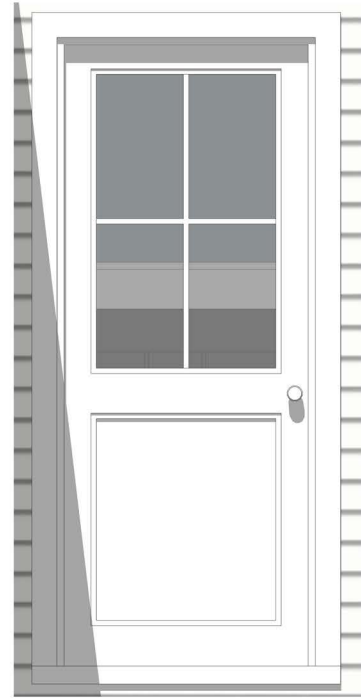
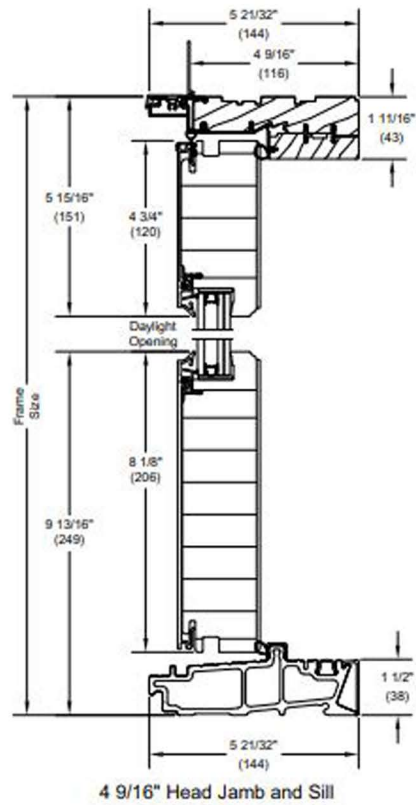

DOOR

PREVIOUSLY APPROVED ON MAIN HOUSE 3/2/22

MANUFACTURER: MARVIN
STYLE: CLAD ULTIMATE

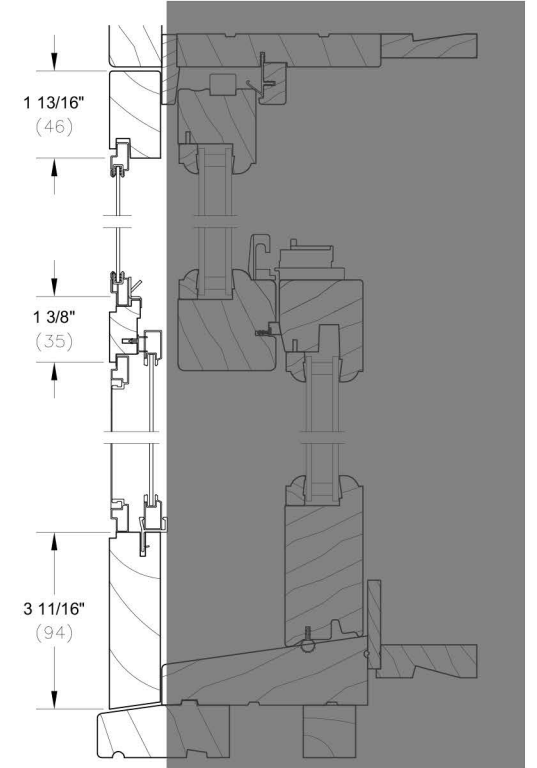

Head Jamb and Sill

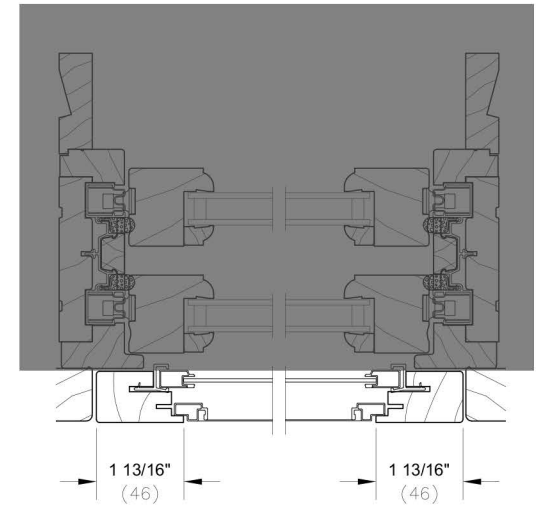

Jambs

PREVIOUSLY APPROVED ON MAIN HOUSE 3/2/22

STORM WINDOWS

MANUFACTURER: MARVIN
STYLE: WOOD



OVERHEAD GARAGE DOOR

MANUFACTURER: CLOPAY
STYLE: CUSTOM
MATERIAL: CEDAR

PROPOSED MATERIALS

HDC APPLICATION TO AMEND PREVIOUS APPROVAL: SEPTEMBER 7, 2022

179 PLEASANT STREET
 PORTSMOUTH, NEW HAMPSHIRE



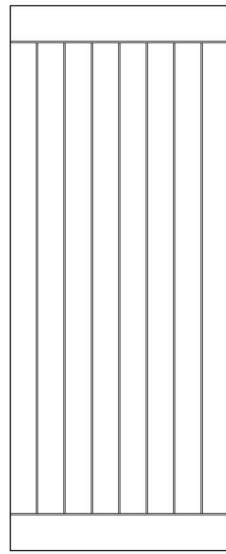

GARAGE DOOR

MANUFACTURER: UPSTATE DOOR
STYLE: CUSTOM V-GROOVES PATTERN
MATERIAL: CEDAR

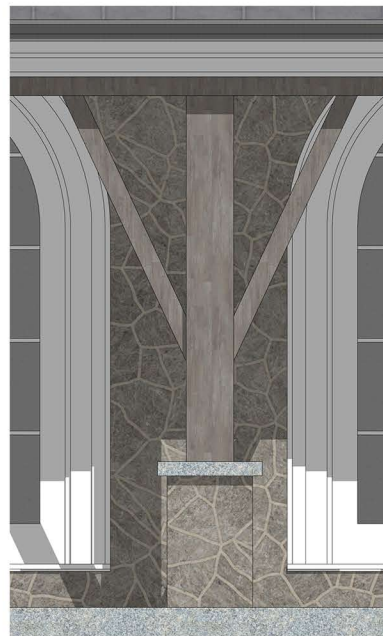

TIMBER POSTS

STYLE: 10x10 POSTS WITH 6x6 BRACKETS & 6x6 BEAM ABOVE
MATERIAL: WHITE OAK

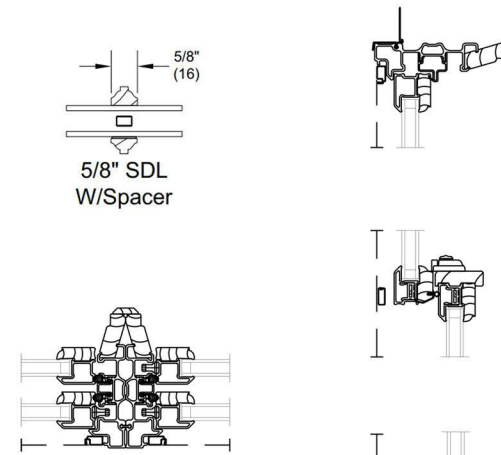
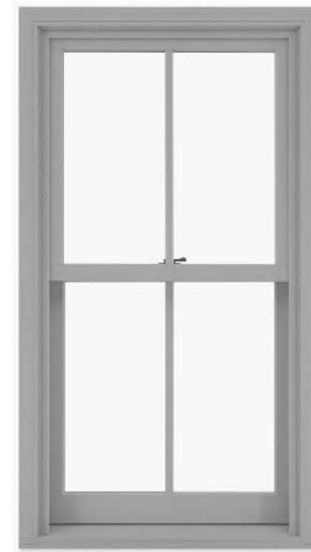

DOUBLE HUNG WINDOWS

MANUFACTURER: MARVIN
STYLE: CLAD ULTIMATE

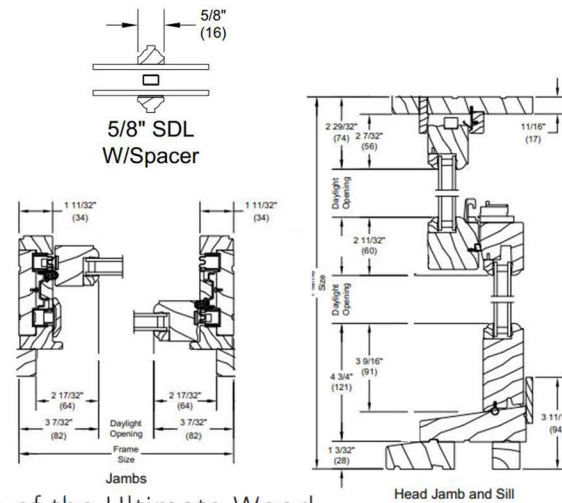

Features of the Ultimate Wood Double Hung Window

- Available in heights up to 8 feet or widths up to 4 feet
- Multiple design options and woods available to match historical aesthetics and design requirements

PREVIOUSLY APPROVED ON MAIN HOUSE 3/2/22

DOUBLE HUNG WINDOWS

MANUFACTURER: MARVIN
STYLE: WOOD ULTIMATE

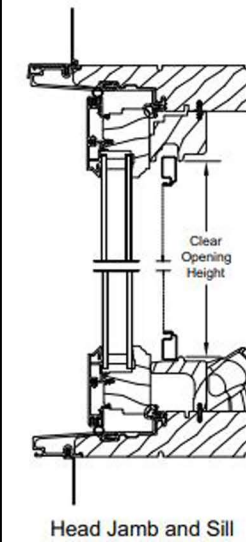

Features of the Clad Ultimate Casement and Awning Window

- Available in heights up to 8.5 feet or widths up to 3.5 feet
- Industry-leading range of size options
- Multi-point locking system ensures a tight seal and security from top to bottom

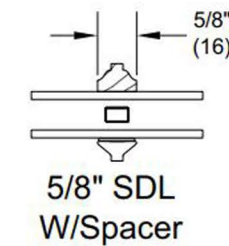

PREVIOUSLY APPROVED ON MAIN HOUSE 3/2/22

CASEMENT WINDOWS

MANUFACTURER: MARVIN
STYLE: CLAD ULTIMATE

179 PLEASANT STREET
 PORTSMOUTH, NEW HAMPSHIRE

PROPOSED MATERIALS

HDC APPLICATION TO AMEND PREVIOUS APPROVAL: SEPTEMBER 7, 2022



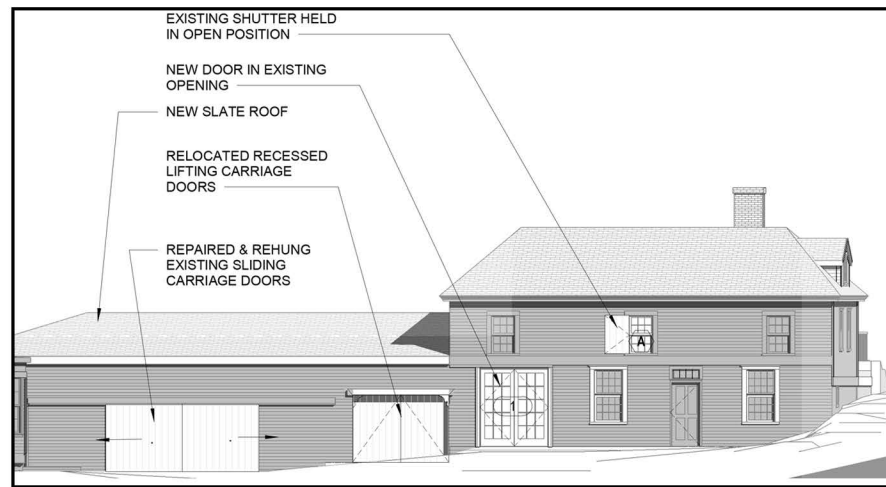

PREVIOUSLY APPROVED FRONT ELEVATION (FOR REFERENCE)



VIEW OF EXISTING FRONT ELEVATION

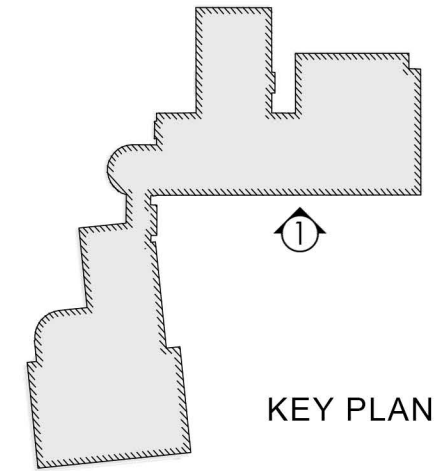

KEY PLAN

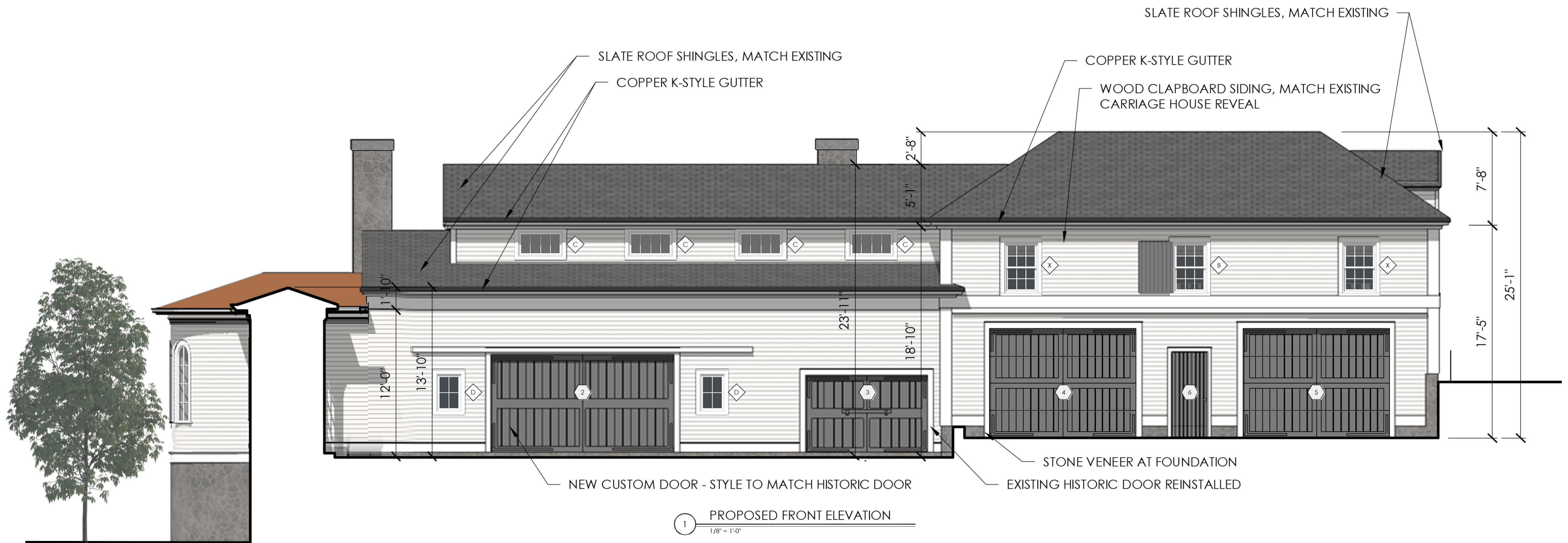

1 PROPOSED FRONT ELEVATION
1/8" = 1'-0"

179 PLEASANT STREET
PORTSMOUTH, NEW HAMPSHIRE

PROPOSED FRONT ELEVATION

HDC APPLICATION TO AMEND PREVIOUS APPROVAL: SEPTEMBER 7, 2022



6.0

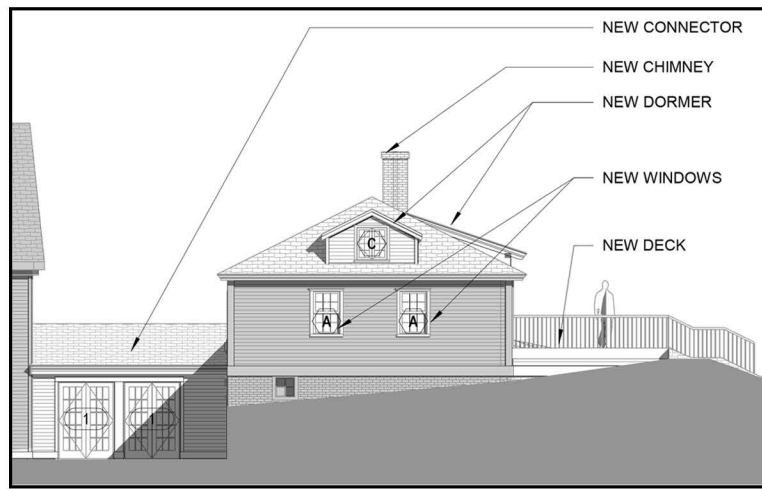

PREVIOUSLY APPROVED SIDE ELEVATION
(FOR REFERENCE)



VIEW OF EXISTING SIDE ELEVATION

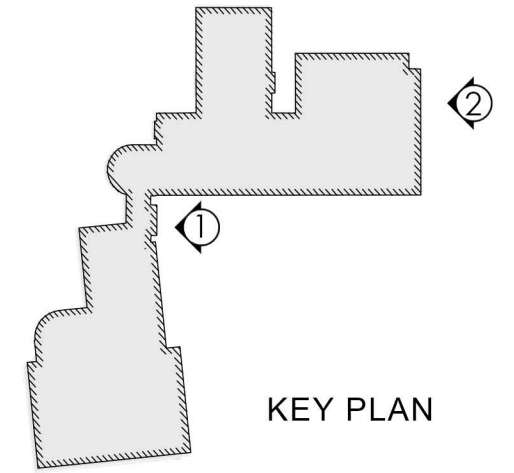

KEY PLAN

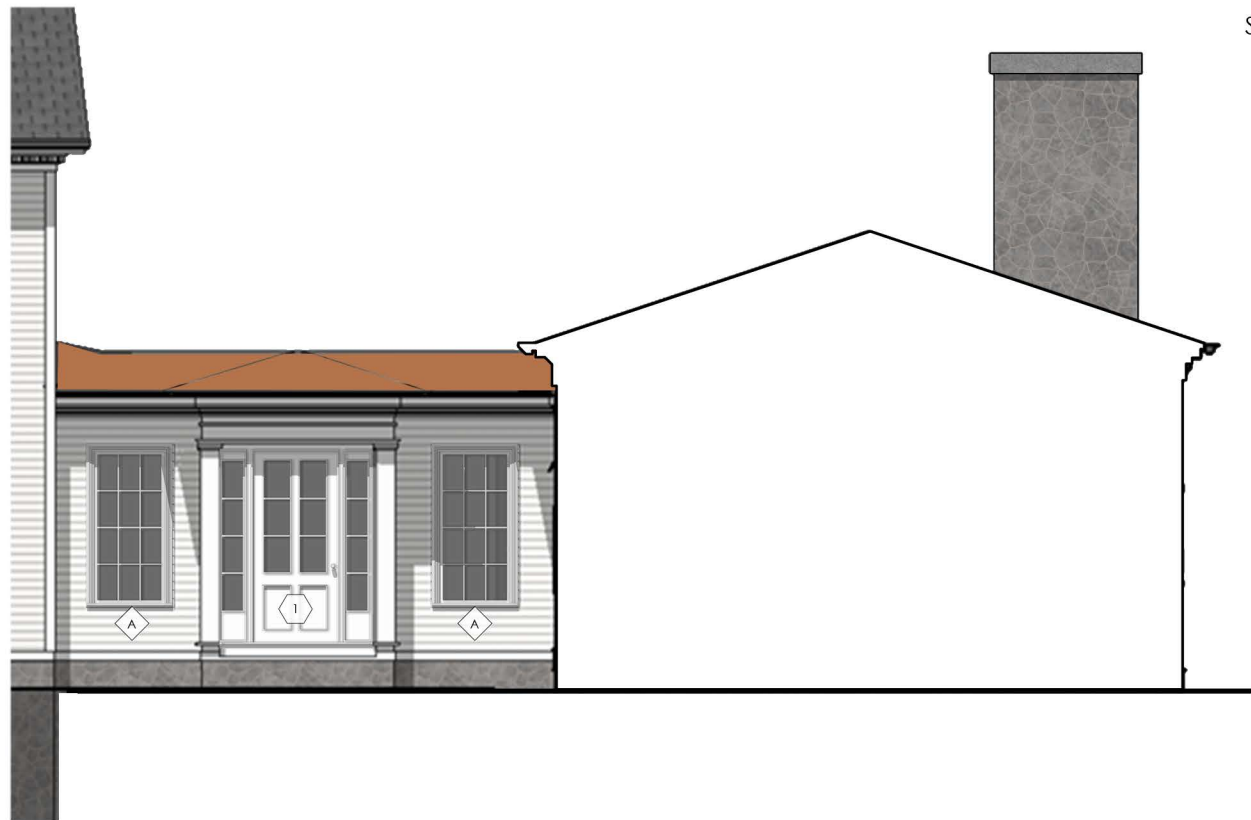

1 PROPOSED SIDE ELEVATION - INSET
1/8" = 1'-0"

SLATE ROOF SHINGLES, MATCH EXISTING

COPPER K-STYLE GUTTER

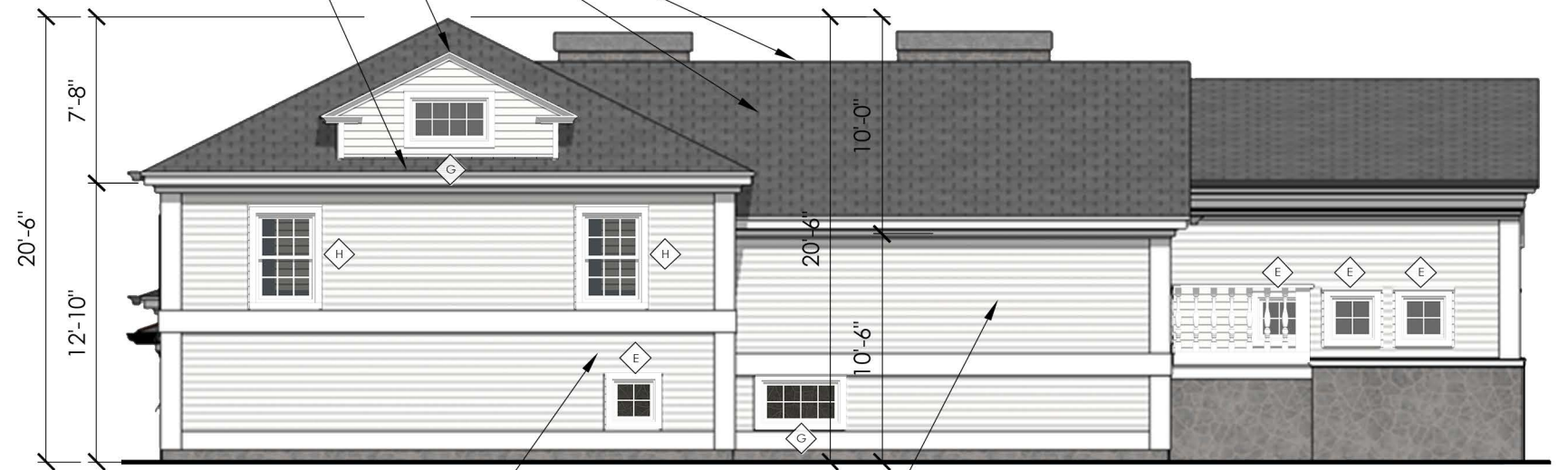

WOOD CLAPBOARD SIDING, MATCH EXISTING CARRIAGE HOUSE REVEAL

WOOD CLAPBOARD SIDING, MATCH EXISTING CARRIAGE HOUSE REVEAL

2 PROPOSED SIDE ELEVATION
1/8" = 1'-0"

179 PLEASANT STREET
PORTSMOUTH, NEW HAMPSHIRE

PROPOSED SIDE ELEVATION

HDC APPLICATION TO AMEND PREVIOUS APPROVAL: SEPTEMBER 7, 2022



6.1

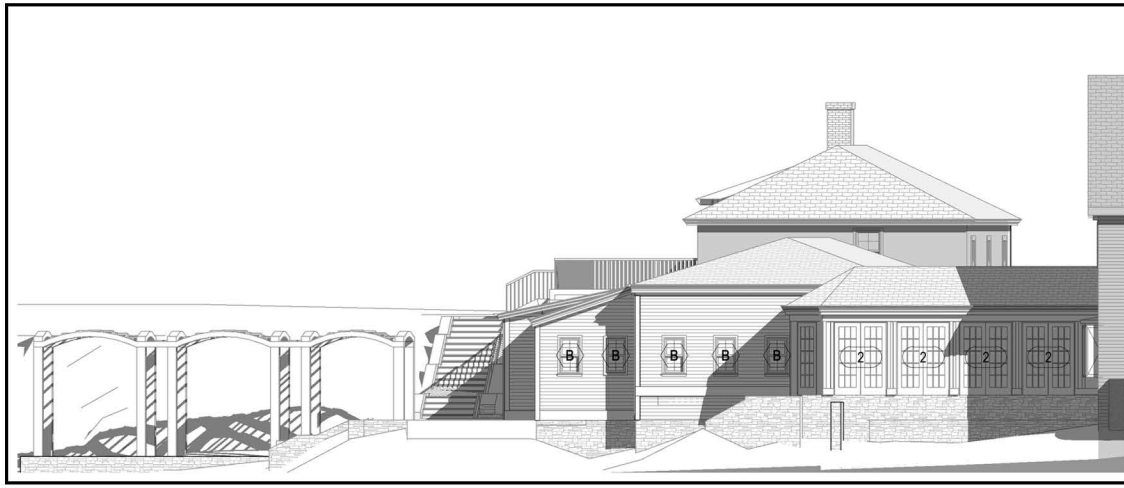

PREVIOUSLY APPROVED SIDE ELEVATION (FOR REFERENCE)



VIEW OF EXISTING SIDE ELEVATION

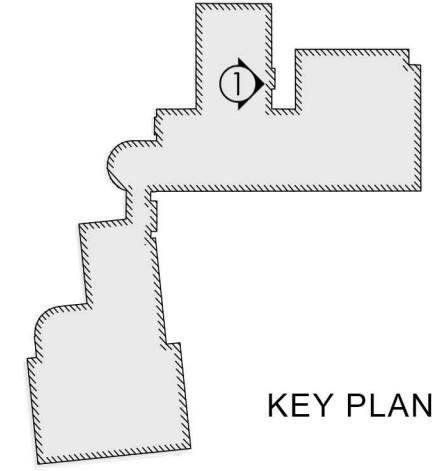

KEY PLAN

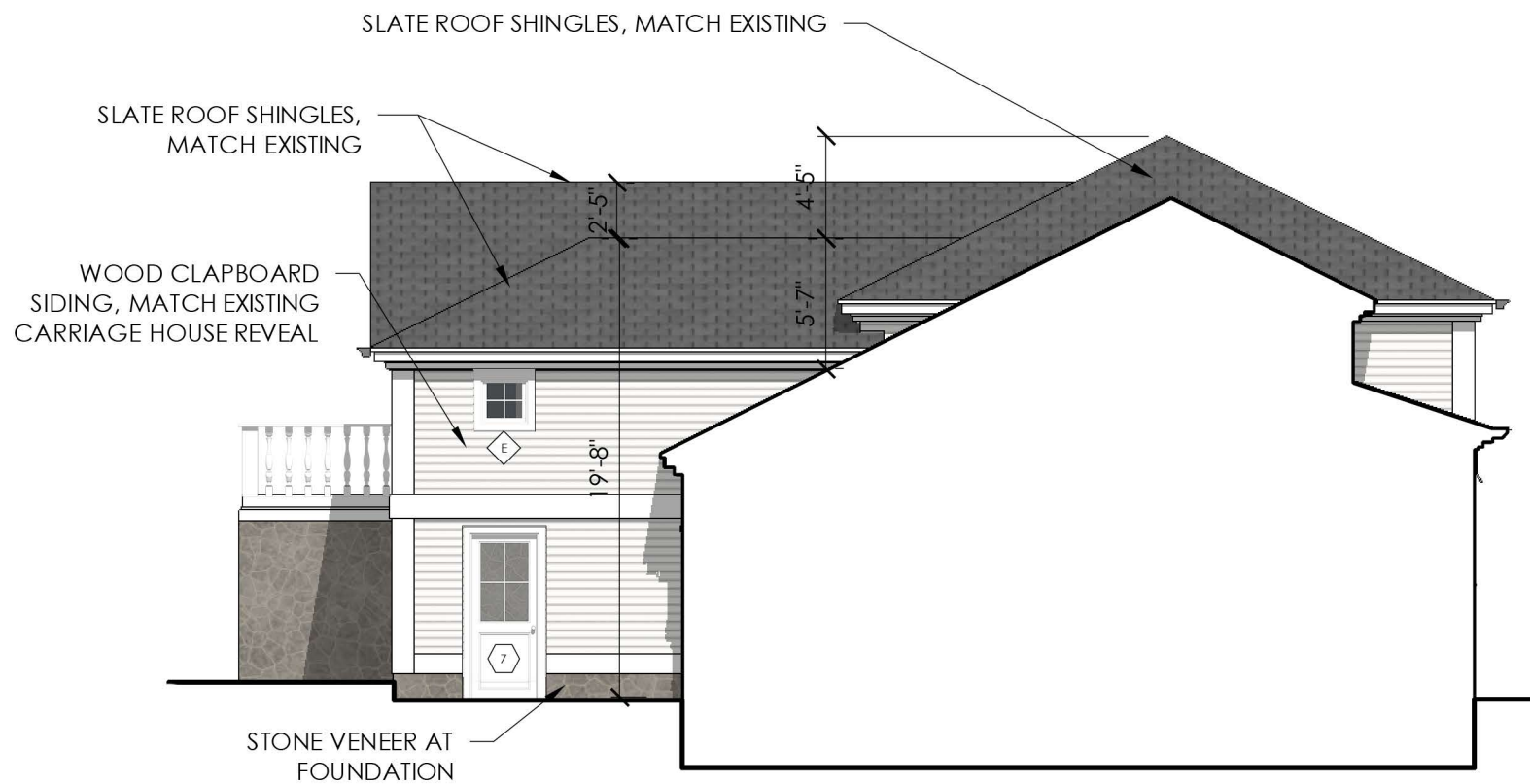

1 EXISTING SIDE ELEVATION - INSET
1/8" = 1'-0"

MARVIN ULTIMATE WINDOWS

- | | |
|--|---|
| <ul style="list-style-type: none"> A CLAD CASEMENT: 3'-1" x 6'-5 5/8" (UCA3678) B WOOD DOUBLE HUNG: 2'-8 3/8" x 4'-1 1/2" (UWDH2620) WITH STORM WINDOWS C CLAD AWNING: 3'-5" x 1'-11 5/8" (UAWNPO4024) D CLAD CASEMENT: 2'-1" x 2'-11 5/8" (UCAPO2436) E CLAD AWNING: 2'-1" x 1'-11 5/8" (AWNPO2424) F CLAD SINGLE HUNG CUSTOM ROUNDTOP: 2'-0" x 6'-5" G CLAD AWNING: 3'-5" x 1'-11 5/8" (UAWNPO4024) H CLAD DOUBLE HUNG: 2'-8 3/8" x 4'-1 1/2" (UDH2620) X WINDOWS TO BE RESTORED AND REINSTALLED WITH STORM WINDOWS | <ul style="list-style-type: none"> 1 3'-8" x 8'-0" CUSTOM CEDAR (ENTRY) 2 15'-0" x 8'-0" CUSTOM CEDAR (SLIDING BARN DOOR) 3 DOOR TO BE RESTORED (HISTORIC BARN DOOR) 4 12'-0" x 9'-0" CUSTOM CEDAR (CLOPAY GARAGE DOOR) 5 12'-0" x 9'-0" CUSTOM CEDAR (CLOPAY GARAGE DOOR) 6 3'-0" x 6'-8" CUSTOM CEDAR (UPSTATE DOOR) 7 3'-0" x 6'-8" MARVIN ULTIMATE CUSTOM CLAD 8 6'-0" x 6'-8" MARVIN ULTIMATE SLIDER 9 3'-0" x 6'-8" MARVIN ULTIMATE CUSTOM CLAD 10 6'-0" x 9'-0" MARVIN CUSTOM CLAD 11 6'-0" x 9'-0" MARVIN CUSTOM CLAD 12 6'-0" x 9'-0" MARVIN CUSTOM CLAD 13 6'-0" x 9'-0" MARVIN CUSTOM CLAD 14 6'-0" x 9'-0" MARVIN CUSTOM CLAD 15 3'-0" x 6'-8" MARVIN ULTIMATE CUSTOM CLAD |
|--|---|

179 PLEASANT STREET
PORTSMOUTH, NEW HAMPSHIRE

PROPOSED SIDE ELEVATION

HDC APPLICATION TO AMEND PREVIOUS APPROVAL: SEPTEMBER 7, 2022



6.2

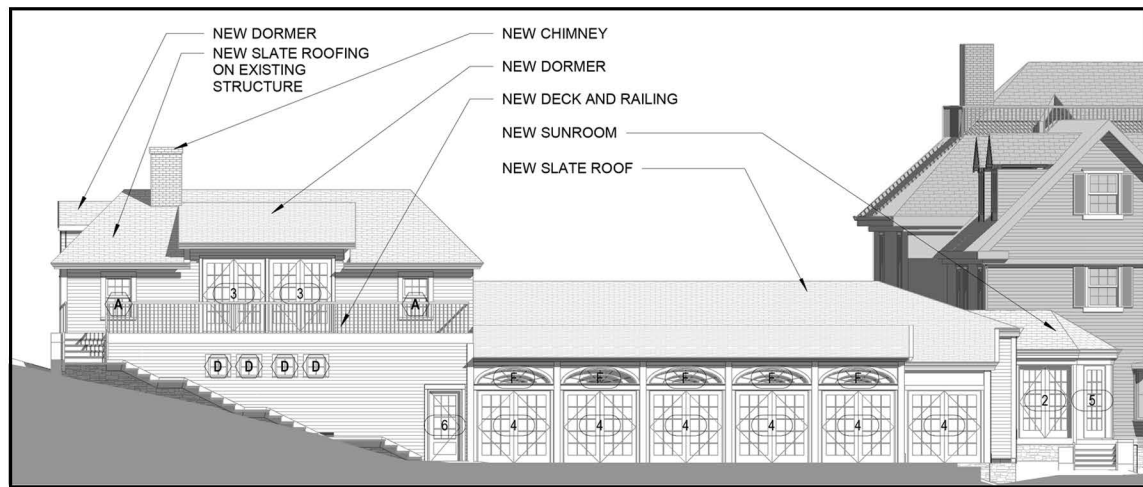

PREVIOUSLY APPROVED REAR ELEVATION (FOR REFERENCE)



VIEW OF EXISTING REAR ELEVATION

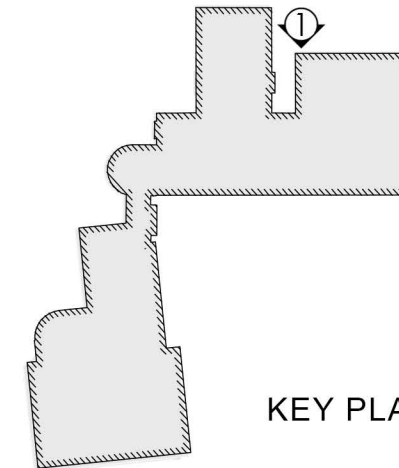

KEY PLAN

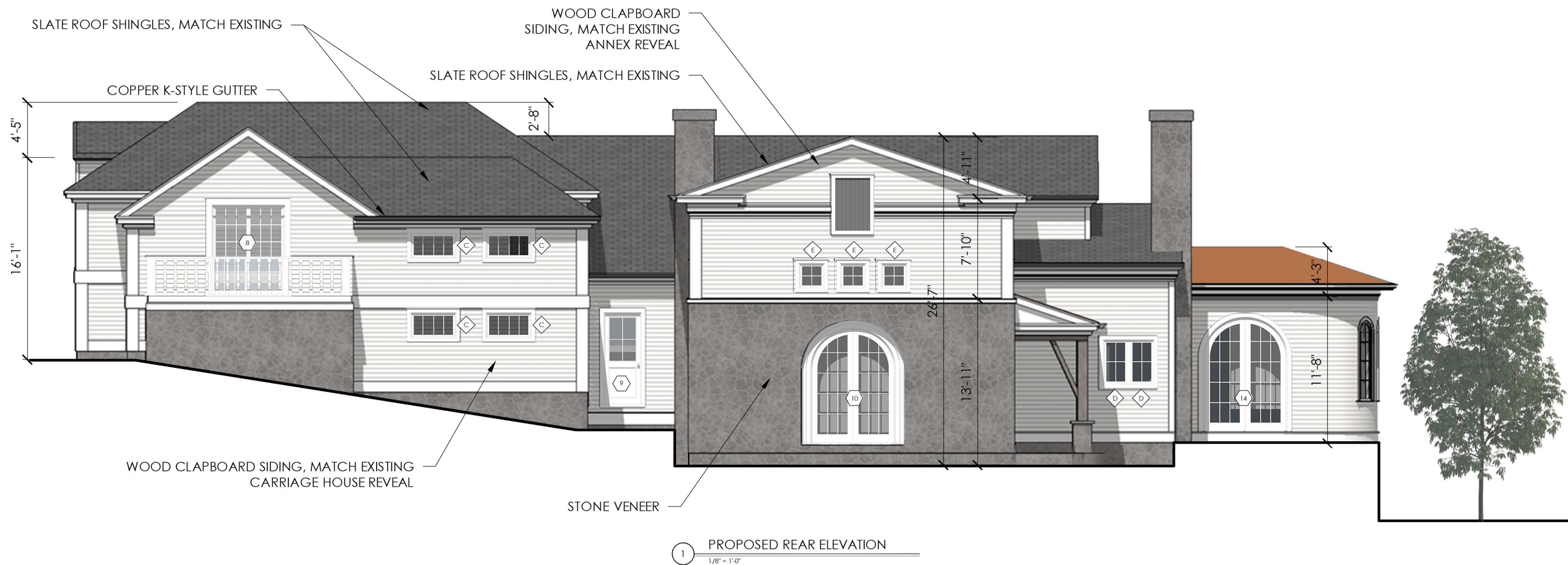

1 PROPOSED REAR ELEVATION
1/8" = 1'-0"

179 PLEASANT STREET
PORTSMOUTH, NEW HAMPSHIRE

PROPOSED REAR ELEVATION

HDC APPLICATION TO AMEND PREVIOUS APPROVAL: SEPTEMBER 7, 2022



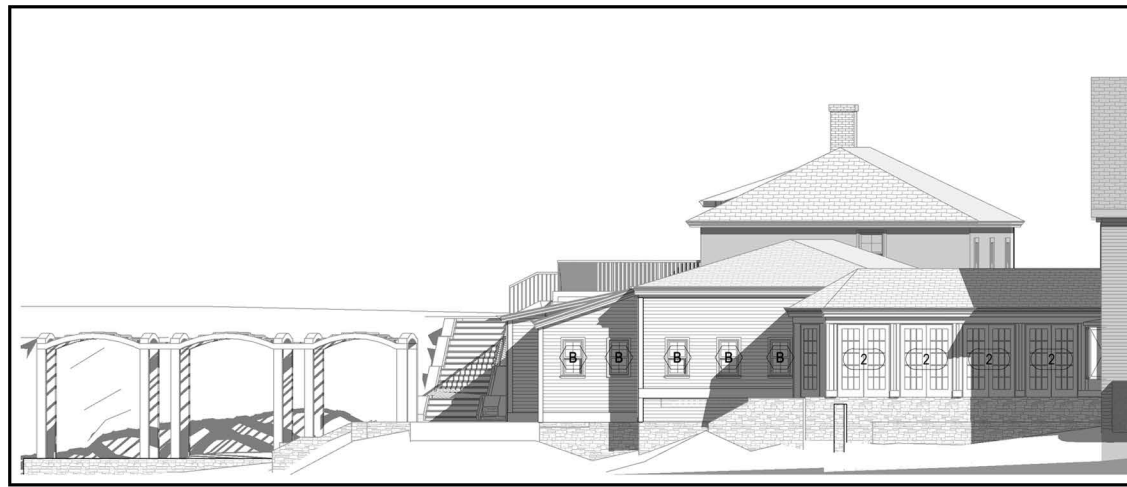

PREVIOUSLY APPROVED SIDE ELEVATION (FOR REFERENCE)



VIEW OF EXISTING SIDE ELEVATION

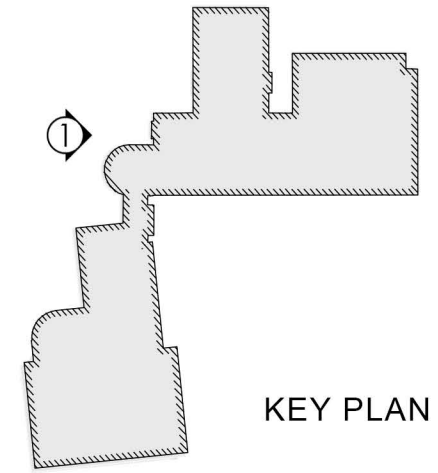

KEY PLAN

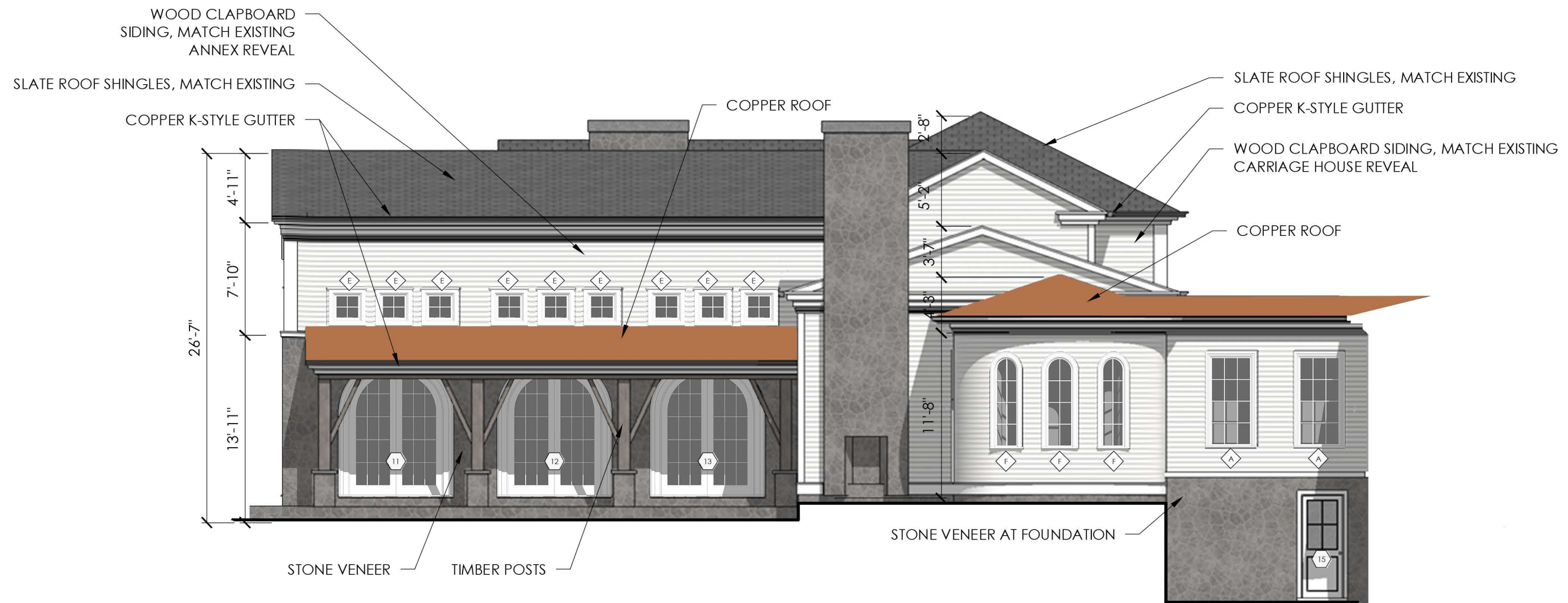

1 PROPOSED SIDE ELEVATION
1/8" = 1'-0"

179 PLEASANT STREET
PORTSMOUTH, NEW HAMPSHIRE

PROPOSED SIDE ELEVATION

HDC APPLICATION TO AMEND PREVIOUS APPROVAL: SEPTEMBER 7, 2022



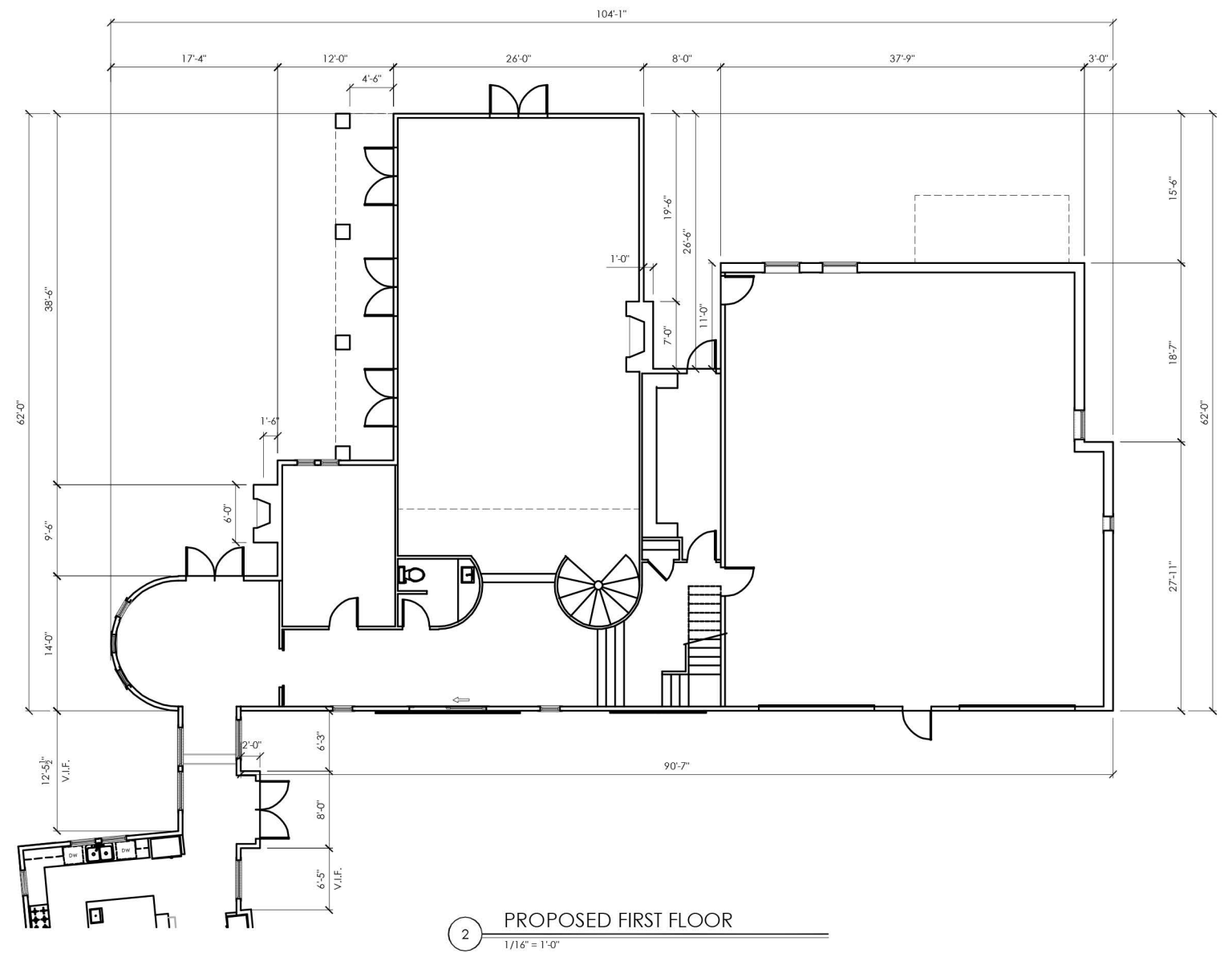
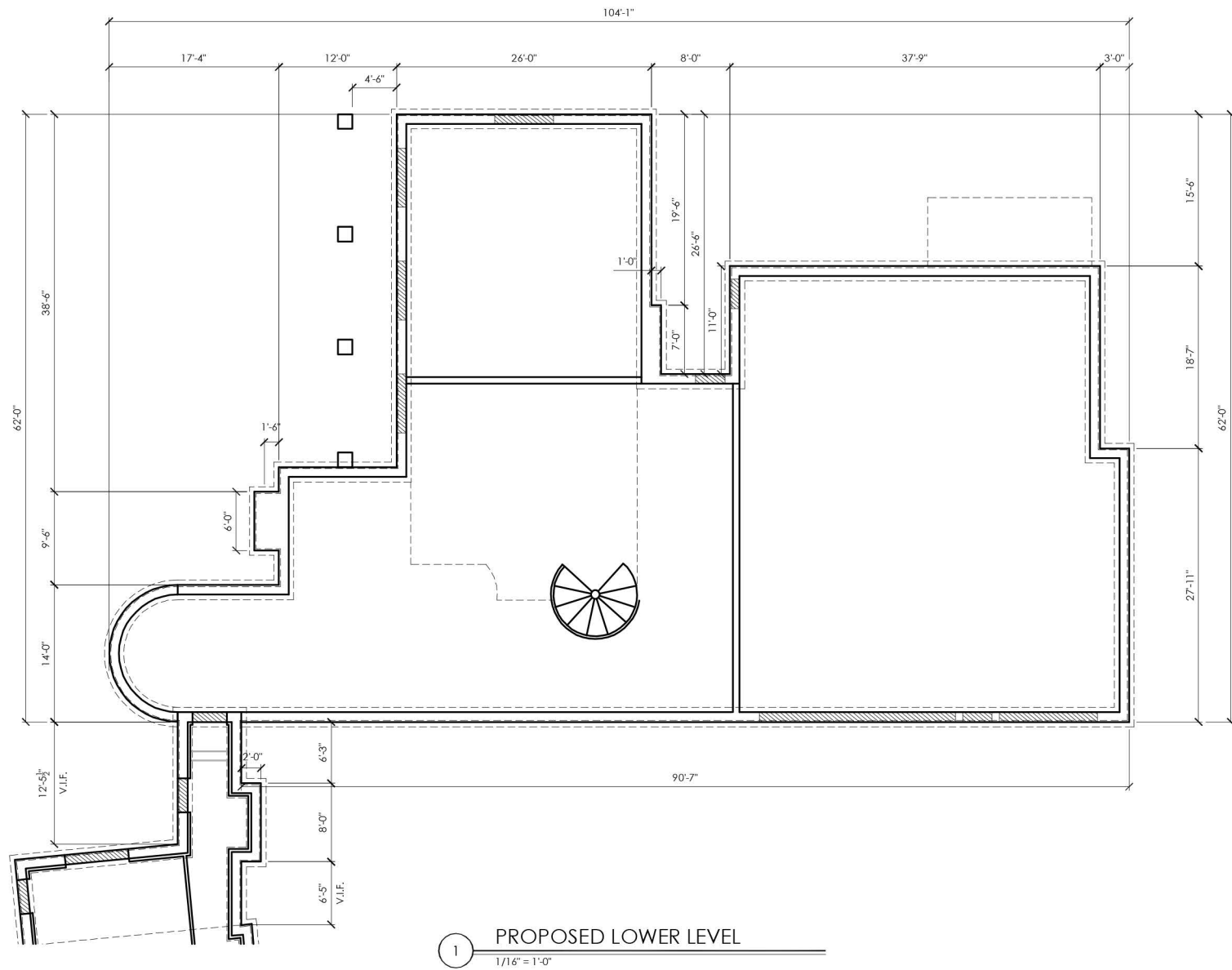

179 PLEASANT STREET
PORTSMOUTH, NEW HAMPSHIRE

PROPOSED PLANS

HDC APPLICATION TO AMEND PREVIOUS APPROVAL: SEPTEMBER 7, 2022



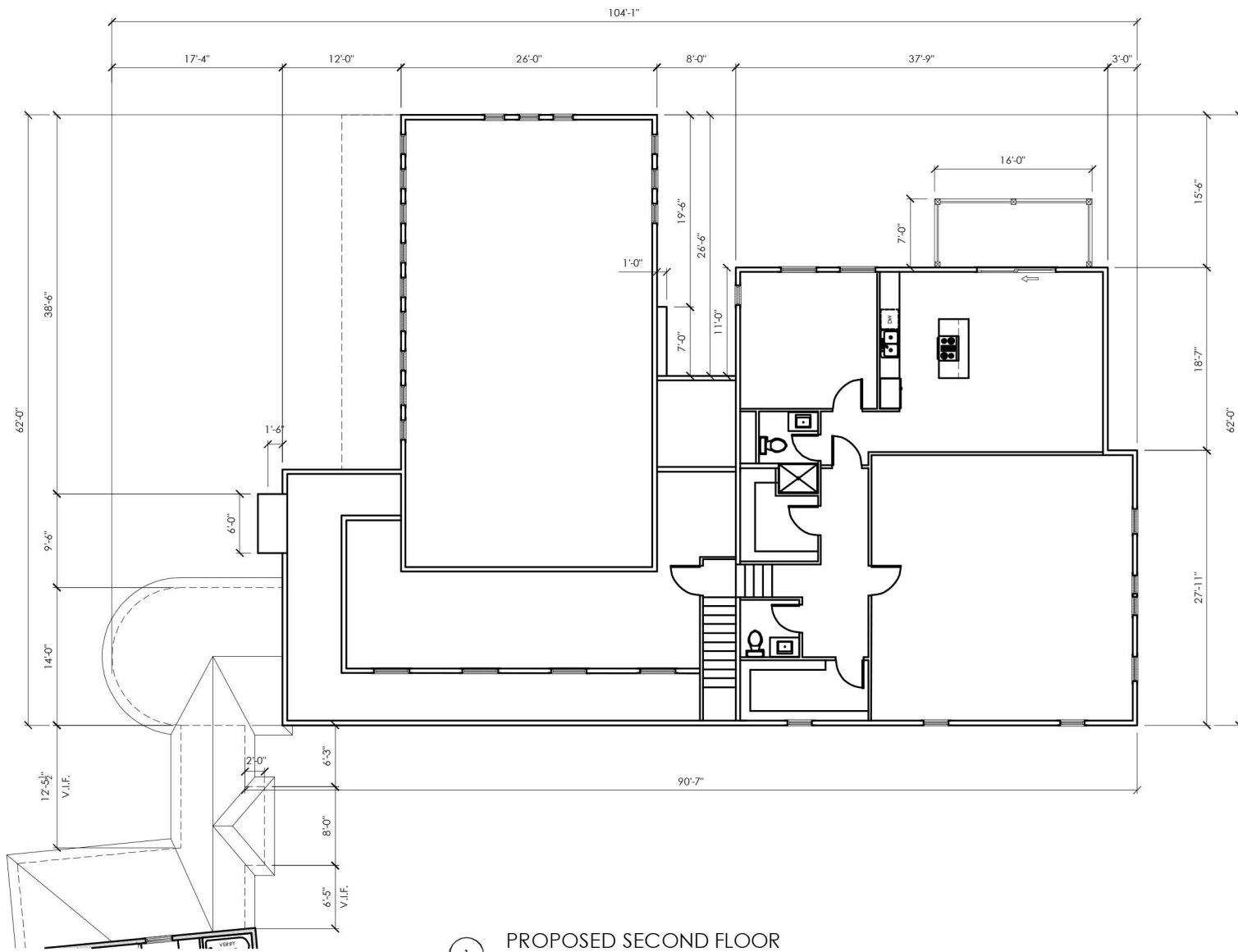

1 PROPOSED SECOND FLOOR
1/16" = 1'-0"

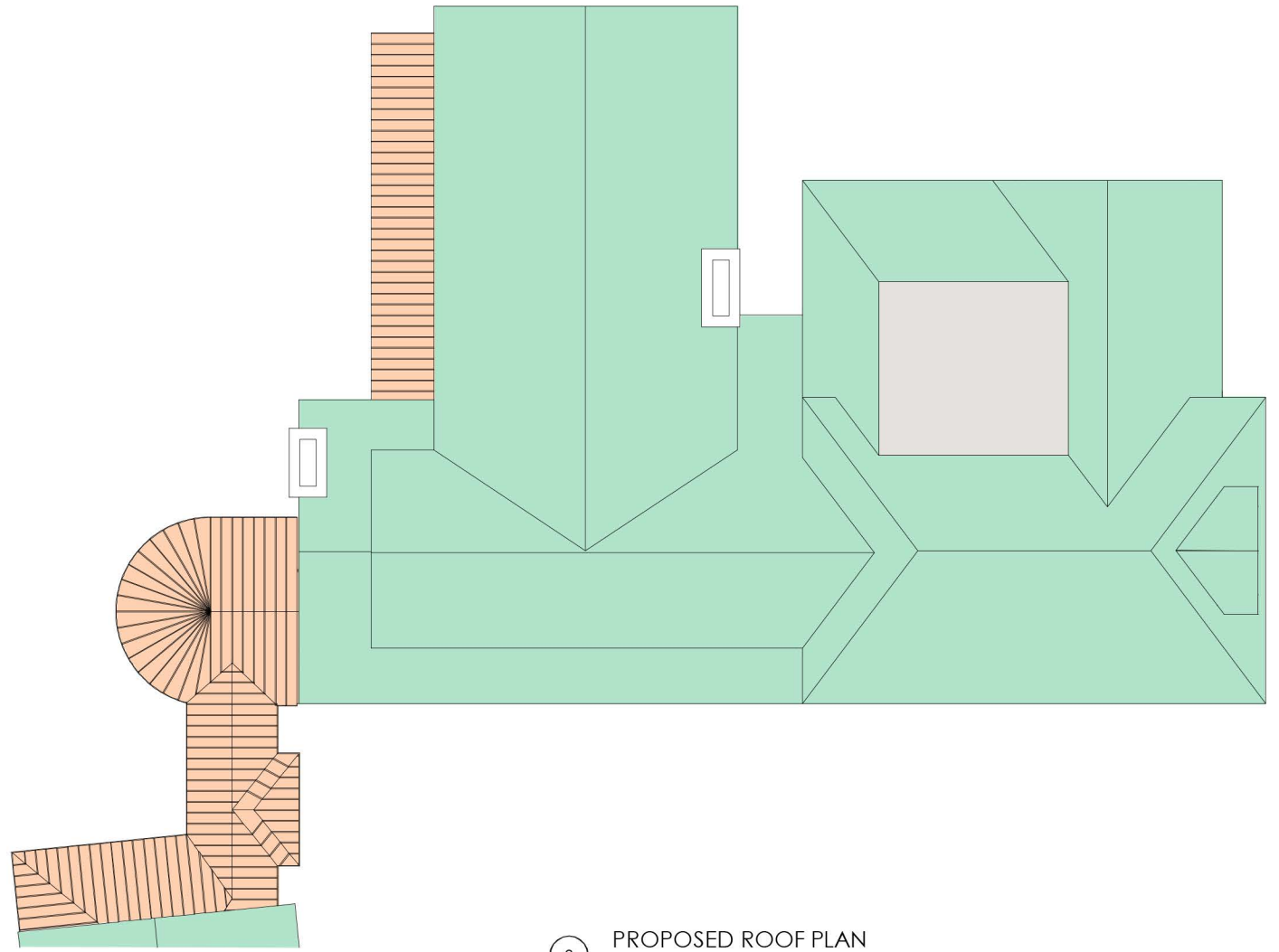

2 PROPOSED ROOF PLAN
1/16" = 1'-0"

- KEY:
- SLATE
 - COPPER
 - RUBBER MEMBRANE

179 PLEASANT STREET
PORTSMOUTH, NEW HAMPSHIRE

PROPOSED PLANS

HDC APPLICATION TO AMEND PREVIOUS APPROVAL: SEPTEMBER 7, 2022



6.6

APPENDIX:

1. Historic Precedents
2. Existing Conditions Documentation of the Three Primary Structures
3. Pedestrian Views of Backyard
4. Property Timeline
5. Historian Consultants
6. Gorham Structural Engineering – Existing Structural Report
7. David Calkins GC & GM – Existing Conditions Evaluation

ARCHITECTURAL 1-1/2 STORY CARRIAGE HOUSE IS HISTORICALLY APPROPRIATE FOR THE PROPERTY AND TIME PERIOD. EXISTING CONNECTOR CONSTRUCTION IS SIGNIFICANTLY COMPROMISED AND MOST REMAINING ORIGINAL STRUCTURE HAS BEEN REMOVED, MODIFIED, AND RECONSTRUCTED.



1. NATHAN PARKER HOUSE (1810) - 46 LIVERMORE STREET, PORTSMOUTH NH



2. NATHAN PARKER HOUSE (1810) - 46 LIVERMORE STREET, PORTSMOUTH NH



3. RUNDLETT MAY HOUSE (1807) - 364 MIDDLE STREET, PORTSMOUTH NH



4. NATHAN PARKER HOUSE (1810) - 46 LIVERMORE STREET, PORTSMOUTH NH

179 PLEASANT STREET
PORTSMOUTH, NEW HAMPSHIRE

HISTORIC PRECEDENTS - CARRIAGE HOUSES

HDC APPLICATION TO AMEND PREVIOUS APPROVAL: SEPTEMBER 7, 2022



7.0

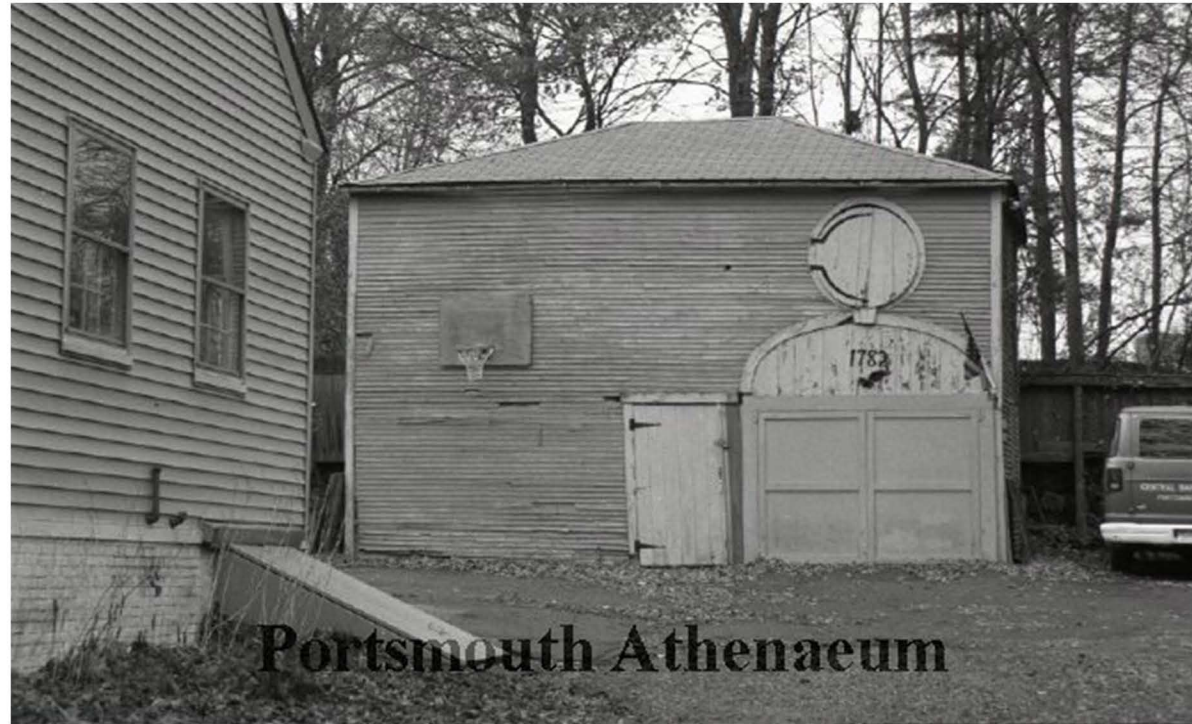

1. 27 AUSTIN STREET, PORTSMOUTH NH

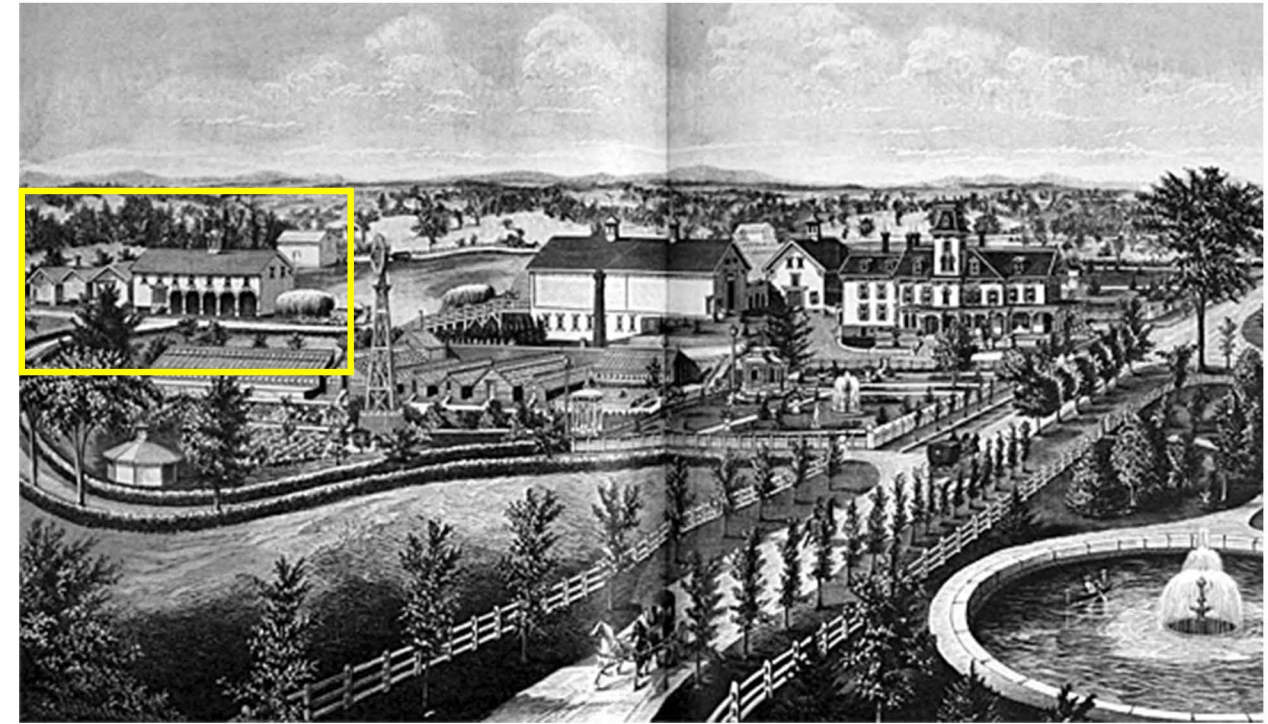

2. FRANK JONES MAPLEWOOD FARM, PORTSMOUTH NH

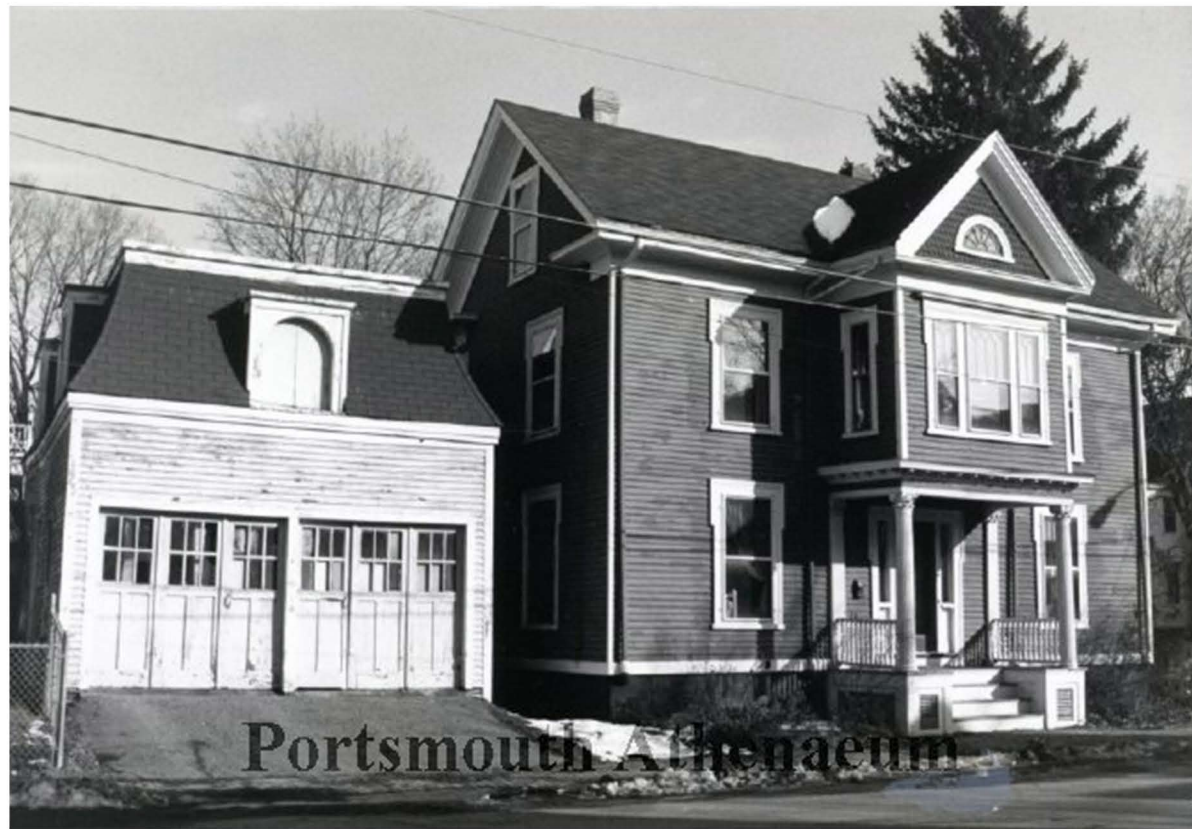

3. 217 CABOT STREET, PORTSMOUTH NH



4. JACOB WENDELL HOUSE (1789) - 214 PLEASANT STREET, PORTSMOUTH NH

179 PLEASANT STREET
PORTSMOUTH, NEW HAMPSHIRE

HISTORIC PRECEDENTS - CARRIAGE HOUSES

HDC APPLICATION TO AMEND PREVIOUS APPROVAL: SEPTEMBER 7, 2022





1. MOFFAT-LADD HOUSE (1763)
154 MARKET STREET, PORTSMOUTH NH



2. 686 MIDDLE STREET, PORTSMOUTH NH



3. 83 MERRIMACK STREET, PORTSMOUTH NH

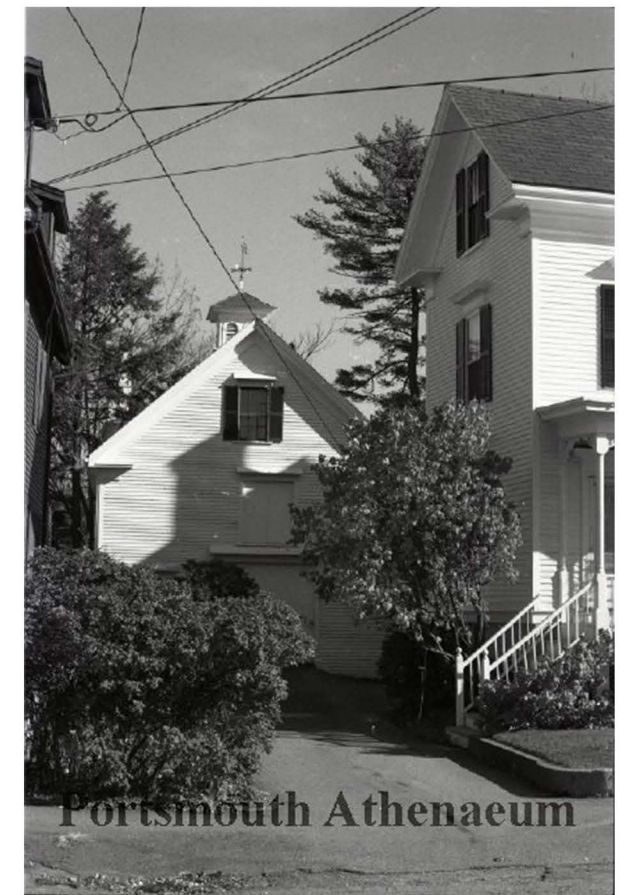

3. 404 MIDDLE STREET, PORTSMOUTH NH

179 PLEASANT STREET
PORTSMOUTH, NEW HAMPSHIRE

HISTORIC PRECEDENTS - CARRIAGE HOUSES

HDC APPLICATION TO AMEND PREVIOUS APPROVAL: SEPTEMBER 7, 2022





A.



B.



C.



D.

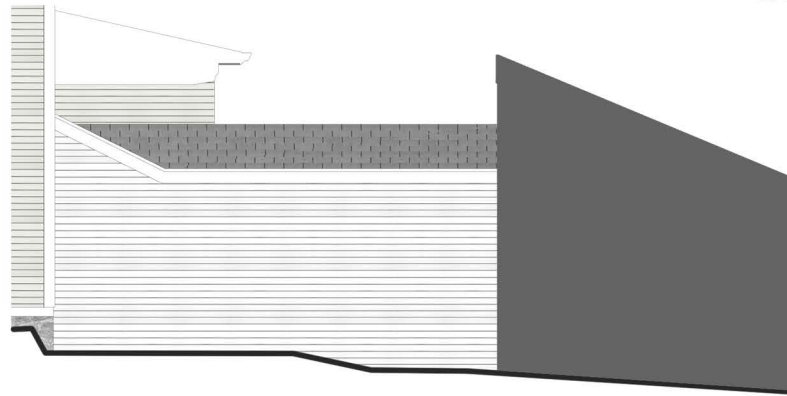

FRONT ELEVATION

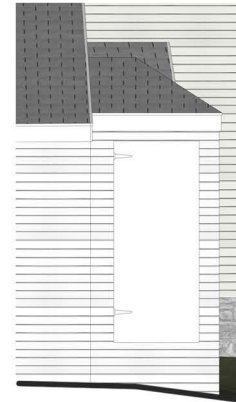

SIDE ELEVATION



REAR ELEVATION



INTERIOR STUDS / PLYWOOD



PRESSURE TREATED SILL REPAIR



BRICK FOUNDATION

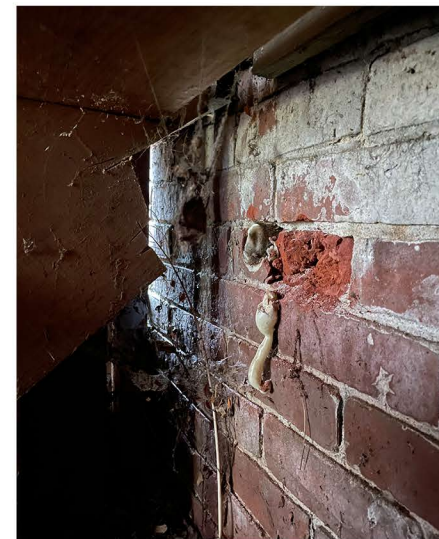

BRICK FOUNDATION



FOUNDATION SLAB

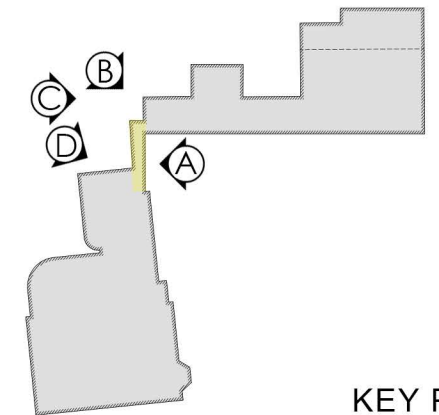

KEY PLAN

179 PLEASANT STREET
PORTSMOUTH, NEW HAMPSHIRE

DOG LEG CONNECTOR - EXISTING CONDITIONS

HDC APPLICATION TO AMEND PREVIOUS APPROVAL: SEPTEMBER 7, 2022





TYPICAL SIDING NAIL



TYPICAL SIDING ROT



TYPICAL SIDING BUTT JOINT



CORNER BOARD NOTCHED AGAINST ANNEX SIDING



INTERSECTION WITH CONNECTOR AT ROOF



FOUNDATION SHELF AND ROT FROM STANDING WATER



INTERSECTION WITH CONNECTOR AT FOUNDATION

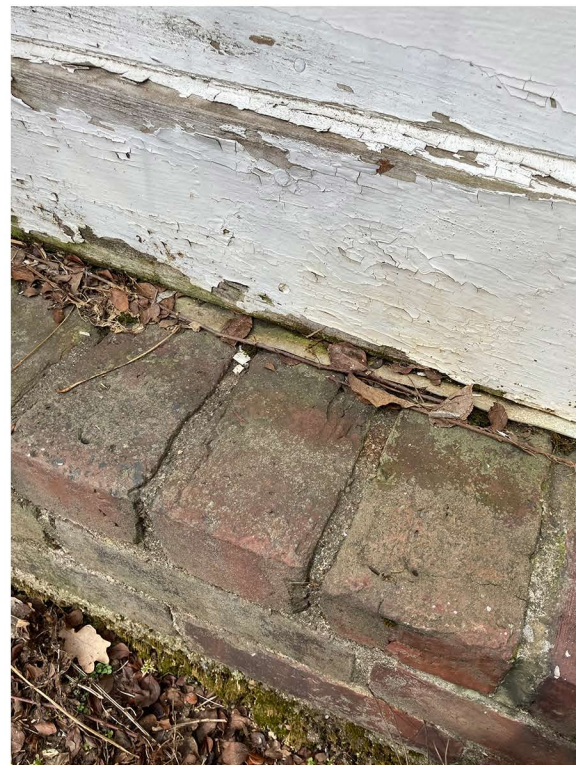

INSUFFICIENT FLASHING



STONE RUBBLE FOUNDATION

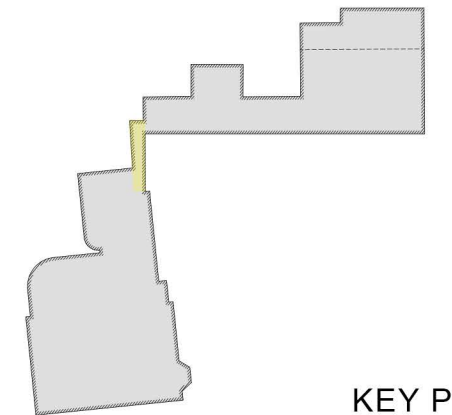

KEY PLAN

179 PLEASANT STREET
PORTSMOUTH, NEW HAMPSHIRE

DOG LEG CONNECTOR - EXISTING EXTERIOR DETAILS

HDC APPLICATION TO AMEND PREVIOUS APPROVAL: SEPTEMBER 7, 2022





A.



B.



C.

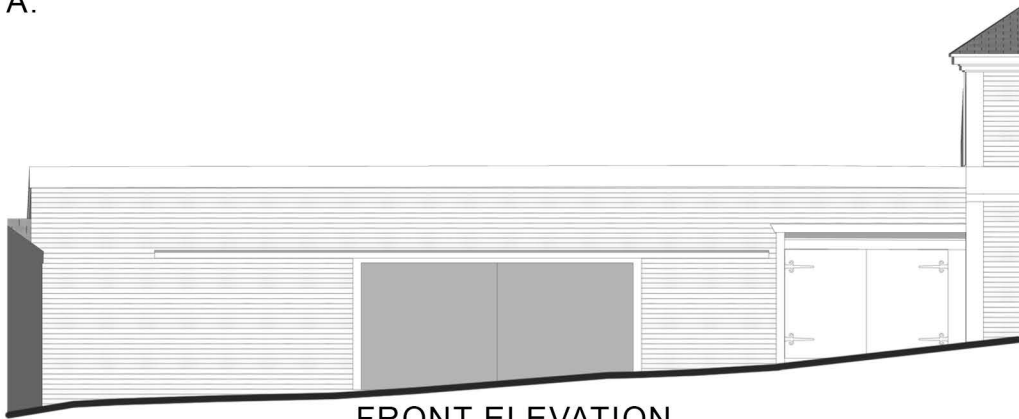

FRONT ELEVATION



SIDE ELEVATION

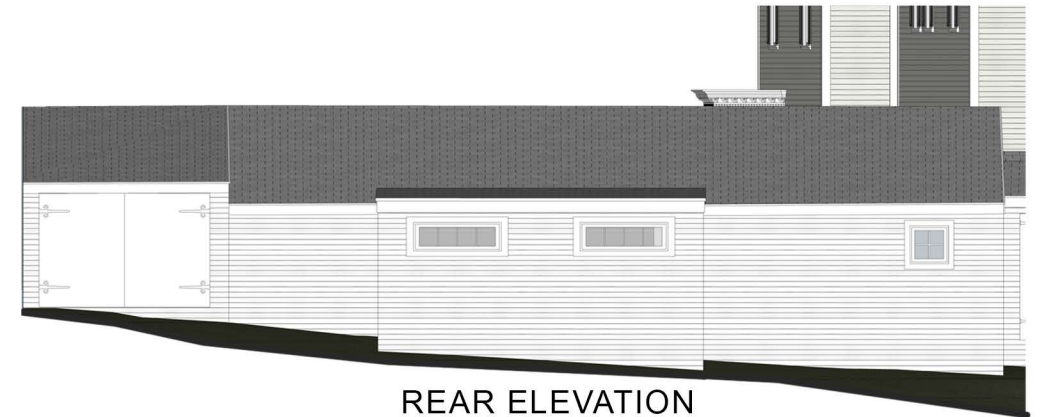

REAR ELEVATION



POST BASE ROT



SIDING ROT



CORNER BOARD ROT



SIDING / CORNER BOARD ROT



SIDING ROT

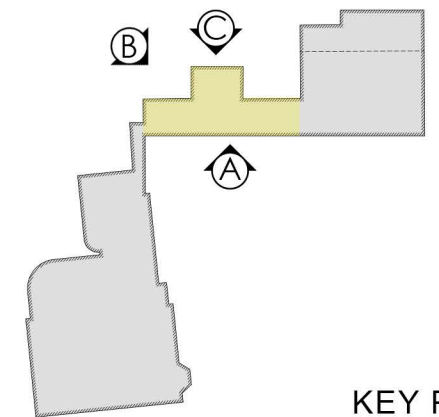

KEY PLAN

179 PLEASANT STREET
PORTSMOUTH, NEW HAMPSHIRE

CONNECTOR - EXTERIOR EXISTING CONDITIONS

HDC APPLICATION TO AMEND PREVIOUS APPROVAL: SEPTEMBER 7, 2022





NEW SIDING



NEW BARN DOOR TRIM COVER



BARN DOOR MORTISE AND TENON



NEW BARN DOOR FRAMING



SIDING ROT AND INSUFFICIENT FLASHING



POSSIBLE HISTORIC CORBEL



POSSIBLE HISTORIC DOOR WITH HISTORIC HINGES

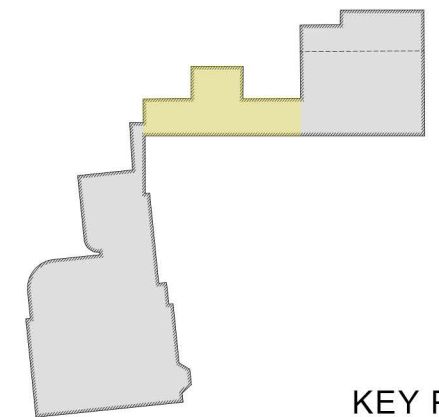

KEY PLAN

179 PLEASANT STREET
PORTSMOUTH, NEW HAMPSHIRE

CONNECTOR - EXISTING EXTERIOR DETAILS

HDC APPLICATION TO AMEND PREVIOUS APPROVAL: SEPTEMBER 7, 2022



7.6



ORIGINAL HINGE (1) ON SMALL DOOR OF CONNECTOR



COMPROMISED STRUCTURE AT BASE



REPAIRS AT COMPROMISED STRUCTURE AT BASE



TYPICAL FLOOR FRAMING MADE UP OF REPURPOSED BEAMS



TYPICAL FLOOR FRAMING MADE UP OF REPURPOSED BEAMS



NEW FRAMING AT 1979 CARPORT

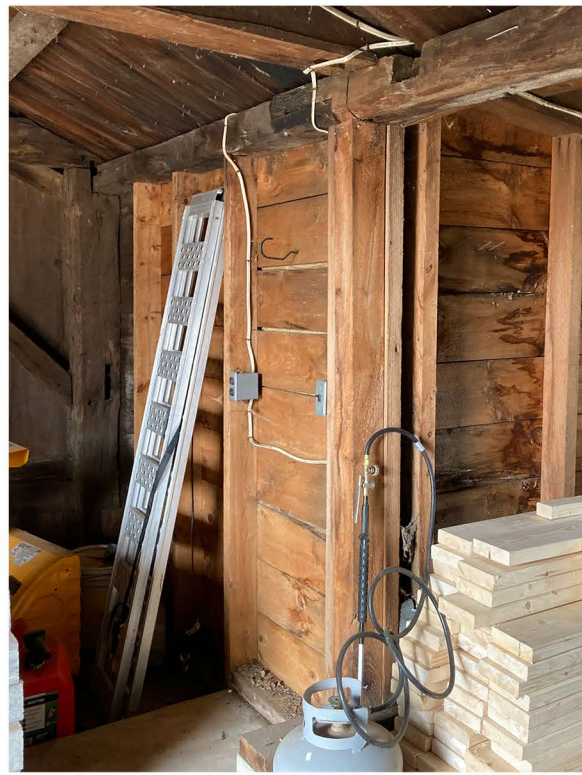

NEW FRAMING AT REAR WALL



TYPICAL FRAMING AT FRONT WALL



TYPICAL HALF LAP POST ROT REPAIR SEEN THROUGHOUT CONNECTOR

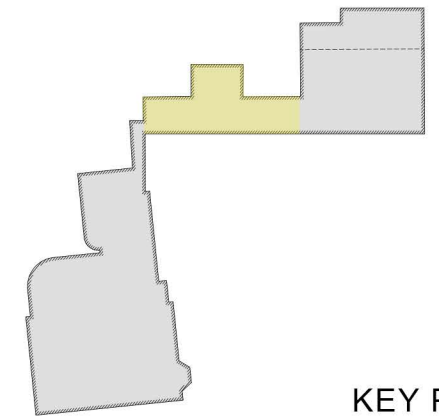

KEY PLAN

179 PLEASANT STREET
PORTSMOUTH, NEW HAMPSHIRE

CONNECTOR - EXISTING INTERIOR DETAILS

HDC APPLICATION TO AMEND PREVIOUS APPROVAL: SEPTEMBER 7, 2022





A.



B.



C.



D.

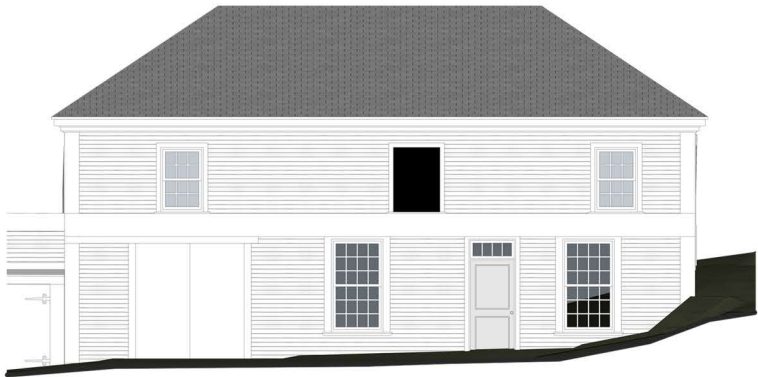

FRONT ELEVATION

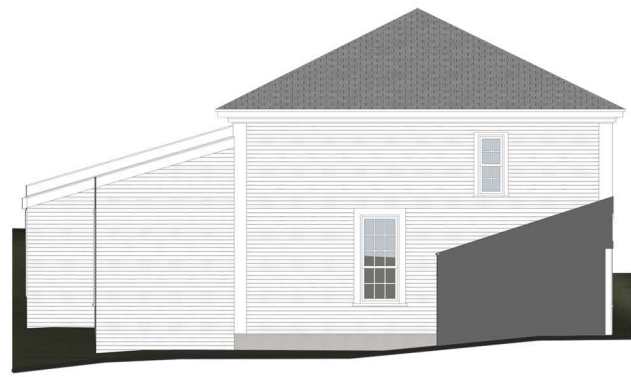

SIDE ELEVATION



REAR ELEVATION

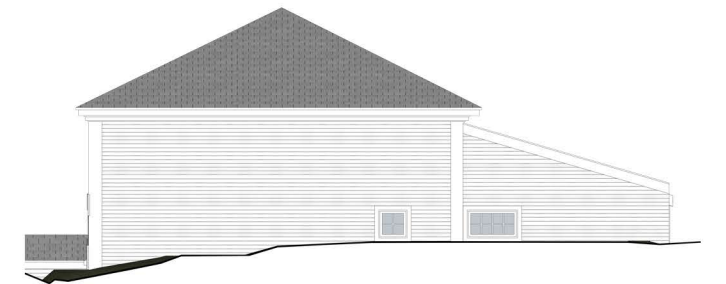

SIDE ELEVATION



SLATE, ASPHALT AND, METAL ROOFING



SILL ROT



WINDOW ROT



WINDOW SILL NEAR/ON GRADE

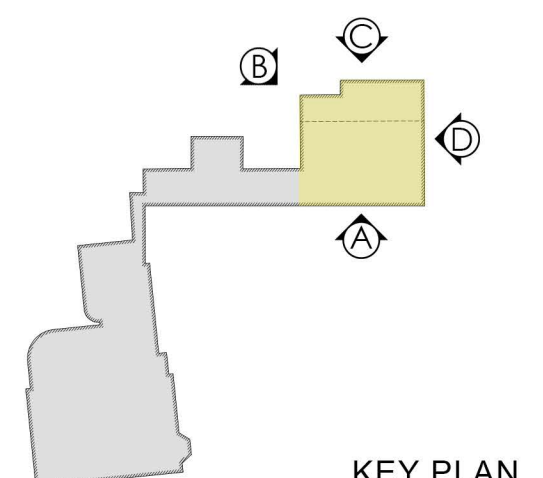

KEY PLAN

179 PLEASANT STREET
PORTSMOUTH, NEW HAMPSHIRE

CARRIAGE HOUSE - EXTERIOR EXISTING CONDITIONS

HDC APPLICATION TO AMEND PREVIOUS APPROVAL: SEPTEMBER 7, 2022



7.8



CRUMBLING FOUNDATION LACKING POSITIVE DRAINAGE



ROT FROM STANDING WATER



NEW WINDOW REPAIR



STONE RUBBLE FOUNDATION AND NEW SIDING REPAIR

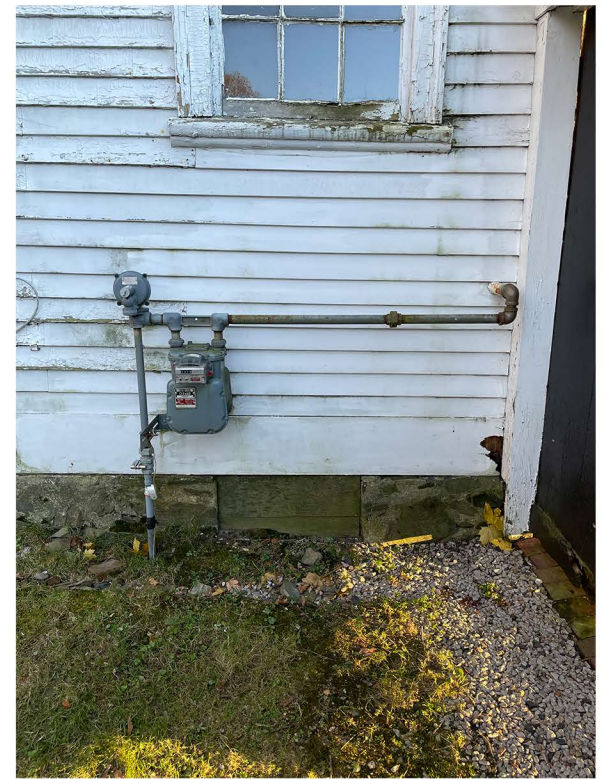

NEW SIDING REPAIR



TYPICAL SIDING ROT



INSUFFICIENT ROOF FLASHING



TYPICAL SIDING ROT AND FOUNDATION DAMAGE

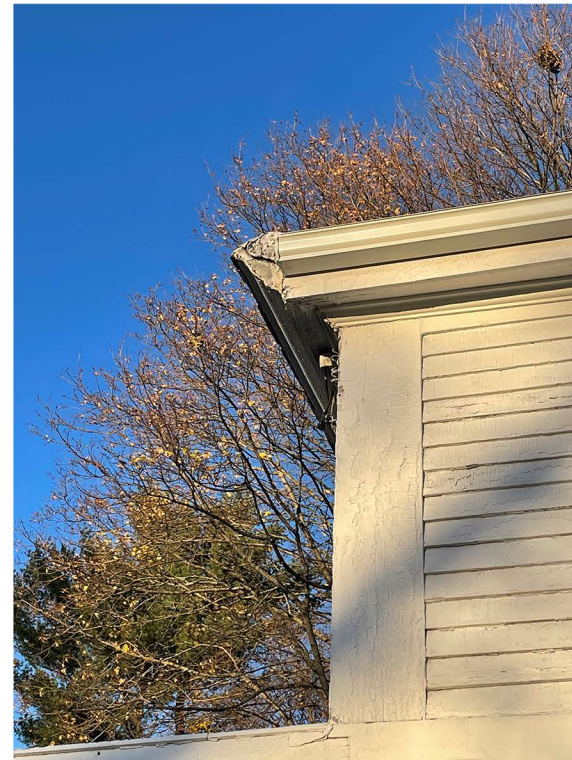

MODIFICATION OF ORIGINAL CORNICE TO INCLUDE GUTTER

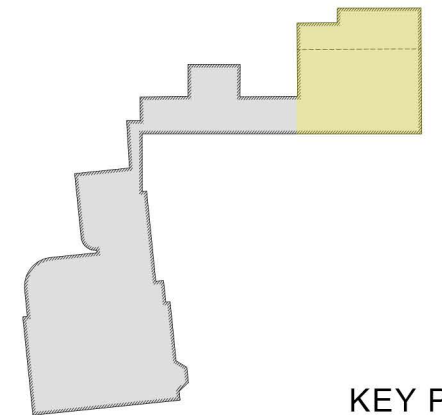

KEY PLAN

179 PLEASANT STREET
PORTSMOUTH, NEW HAMPSHIRE

CARRIAGE HOUSE - EXISTING EXTERIOR DETAILS

HDC APPLICATION TO AMEND PREVIOUS APPROVAL: SEPTEMBER 7, 2022





TYPICAL BEAMS IN DIRECT CONTACT WITH GROUND



TYPICAL BEAMS IN DIRECT CONTACT WITH GROUND



TYPICAL NEW FRAMING



TYPICAL HISTORIC FRAMING

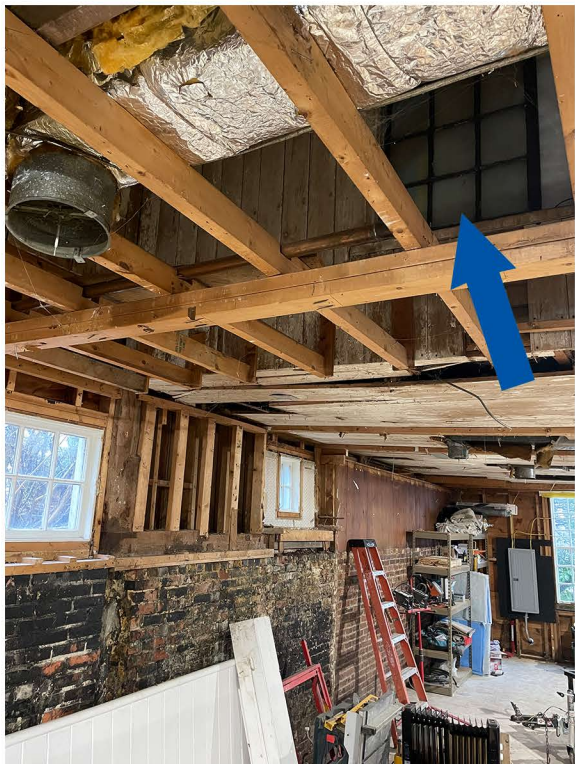

EXISTING WINDOW LOCATED AT REAR OF ORIGINAL CARRIAGE HOUSE BLOCK

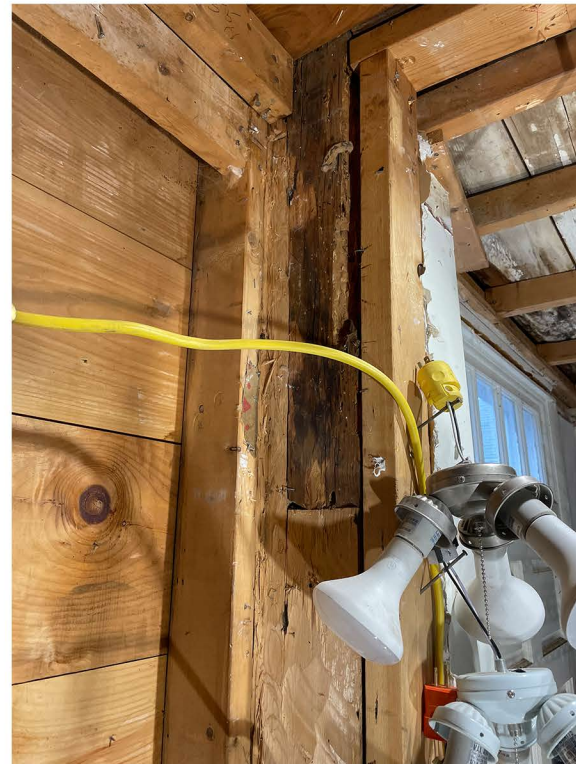

TYPICAL NEW FRAMING COMBINED WITH OLDER MODIFIED FRAMING



OLDER FRAMING MEMBERS HAVE BEEN MODIFIED, REMOVED, OR RELOCATED. (SECOND FLOOR OF CARRIAGE HOUSE)



OLDER FRAMING MEMBERS HAVE BEEN MODIFIED, REMOVED, OR RELOCATED. (SECOND FLOOR OF CARRIAGE HOUSE)

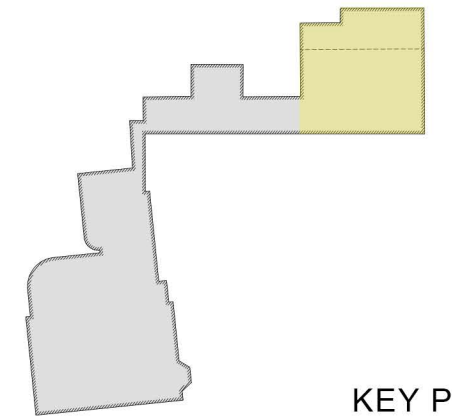

KEY PLAN

179 PLEASANT STREET
PORTSMOUTH, NEW HAMPSHIRE

CARRIAGE HOUSE - EXISTING INTERIOR DETAILS

HDC APPLICATION TO AMEND PREVIOUS APPROVAL: SEPTEMBER 7, 2022



7.10

VISIBILITY OF PROJECT AREA FROM SURROUNDING PROPERTIES AND PUBLIC SIDWALKS IS VERY OBSCURED BY BOTH BUILDINGS, FENCING AND, MATURE LANDSCAPE.



A. VIEW OF BACKYARD FROM PLEASANT STREET



B. VIEW OF BACKYARD FROM LANGDON'S DRIVEWAY

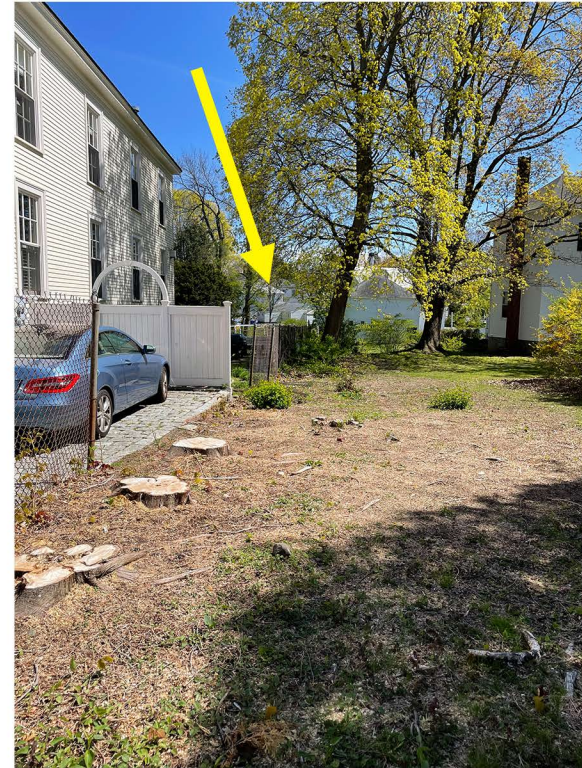

C. VIEW OF BACKYARD FROM COURT STREET



D. VIEW OF BACKYARD FROM LANGDON'S BACKYARD

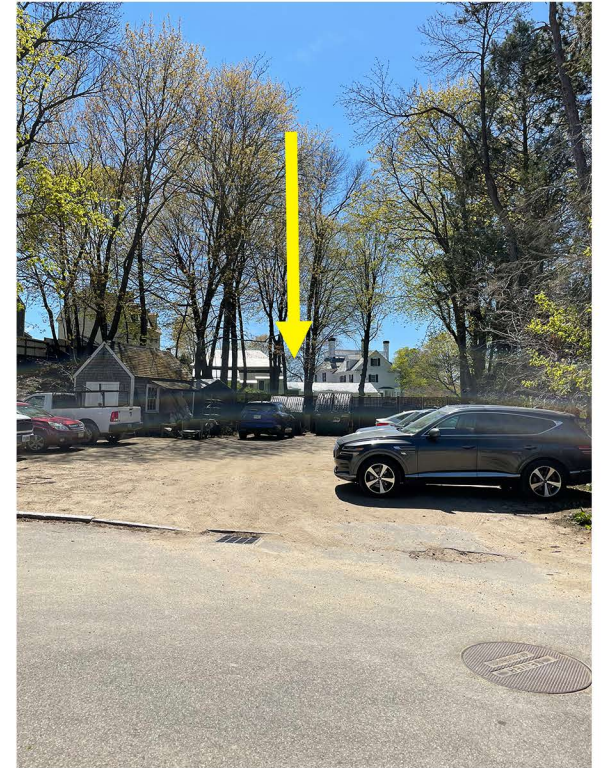

E. VIEW OF BACKYARD FROM WASHINGTON ST.



F. VIEW OF BACKYARD FROM RICHMOND ST.

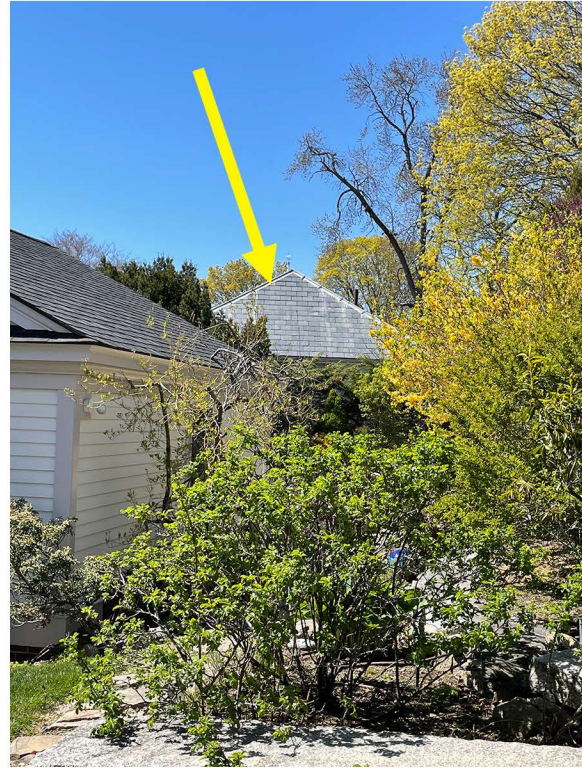

G. VIEW OF BACKYARD FROM RICHMOND ST.

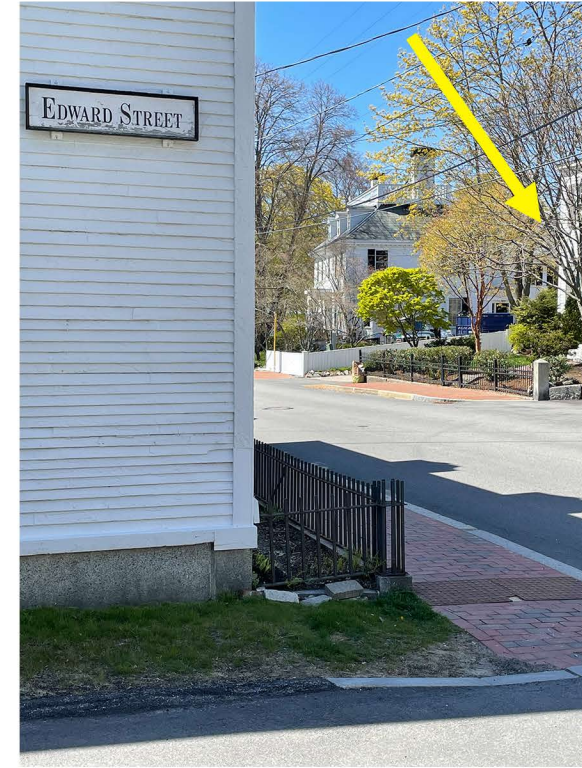

H. VIEW OF BACKYARD FROM EDWARD ST.

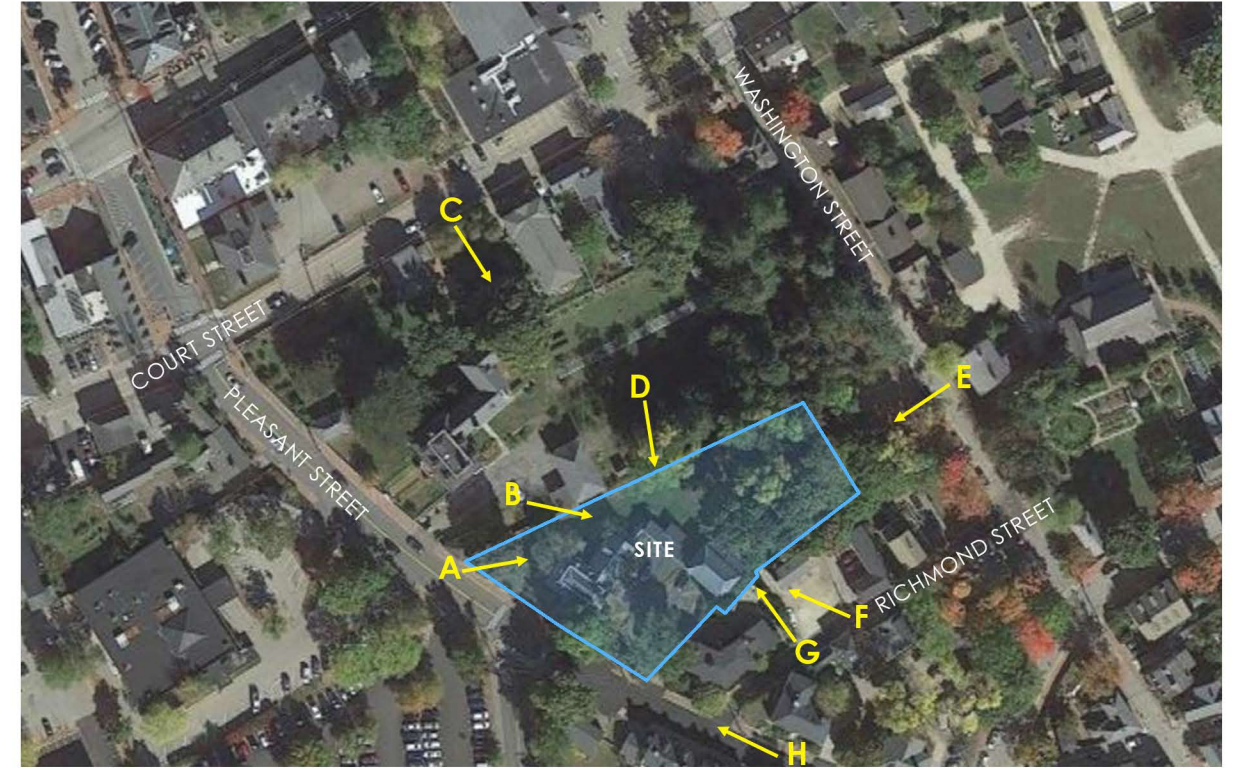

KEY PLAN

179 PLEASANT STREET
PORTSMOUTH, NEW HAMPSHIRE

PEDESTRIAN VIEWS OF BACKYARD

HDC APPLICATION TO AMEND PREVIOUS APPROVAL: SEPTEMBER 7, 2022



7.11

PROPERTY TIMELINE: Sources: Portsmouth Athenaeum - Portsmouth Permitting Archives

- 1780's:** Captain Thomas Thompson House is Constructed (same time period John Langdon built his house next door)
- 1859:** Mark H. Wentworth purchased the house from the Thompson Family and made several Victorian improvements
- 1903:** Mark H. Wentworth passed away and leaves the house to his daughter Susan J. Wentworth
- 1940:** Susan J. Wentworth passed away and the house is owned by several people
- 1962:** Doctors office is approved and built in carriage house
- 1978:** Kitchen added to the apartment in main house, apartment was used as housekeeper quarters.
- 1979:** 10 x 16 addition added as "carport" to rear of connector building
- 1979:** Single family house was approved as "duplex"
- 1980:** Remodel 2nd floor bathroom
- 1981:** Remodel kitchen and add kitchen powder room, remodel 2 other bathrooms in house
- 1982:** Sun porch was added as 3 season structure, was a garden terrace prior
- 1983:** Widows walk was reproduced, only on the front of the building
- 1983:** Apartment was remodeled in main house
- 1984:** Widows walk was expanded to all four sides of the house
- 1986:** The lot was sub-divided into 2 lots 179 & 181 (This is not clear)
- 1986:** Carriage house was remodeled and expanded upon
- 1988:** Sun porch was reroofed, and door added from main house to access roof top
- 1988:** 3rd floor of main house was extensively renovated and finished with new living space, skylights added
- 2003:** Lot line adjustment on right side of 181
- 2005:** Lots 179 & 181 are voluntarily merged
- 2014:** Widows walk completely reproduced on all 4 sides
- 2018:** Larger garage door was installed in carriage house and misc. in-fill framing
- 2018:** Section of wooden fence was replaced on the front only
- 2019:** HDC Certificate of Approval granted for renovations and expansions
- 2020:** 1-year extension granted for HDC Certificate of Approval granted for renovations and expansions
- 2020:** Flooring in carriage house was removed and stored
- 2021:** [New Ownership](#)
- 2021:** [Permit Issued for nonstructural demolition](#)

HISTORIAN CONSULTANTS

John Schnitzler - Attended 2021-12-21 Walkthrough
Master Carpenter - Strawberry Banke

Elizabeth Farish - Attended 2021-12-21 Walkthrough
Chief Curator – Strawberry Banke

Tom Hardiman - Assistance in Historic Research
Keeper – Portsmouth Athenaeum

Steven Mallory - Attended 2022-01-10 Walkthrough
Preservation Historian

Bruce Blanchard - Attended 2022-01-12 Langdon & Thompson House Walkthroughs
Preservation Manager for the Piscataqua Area - Historic New England

Melissa Kershaw - Attended 2022-01-12 Langdon & Thompson House Walkthroughs
Regional Site Administrator, Northern New England - Historic New England

Dylan Peacock - Attended 2022-01-12 Langdon & Thompson House Walkthroughs
Senior Preservation Services Manager - Historic New England

Tim Barry – Attended 2022-02-08 Walkthrough
Historic Painter

13 April, 2022

Structural Condition Assessment
Connector, Barn and Carriage House
Captain Thomas Thompson House
179 Pleasant Street
Portsmouth, New Hampshire

Gorham Structural Engineering, PLLC is a consultant to the property owner and has been retained to work with project architect, CJ Architects, to provide a condition assessment of the connector, barn and carriage house structures at 179 Pleasant Street. The following is a summary of the findings.

Please see attached sketch SK-A for a plan drawing.

1.0 Connector

The connector is a 4'-3"x23'-9" one story, wood framed structure which extends from the back of the annex to the barn.

The connector foundation is made of loosely spaced stone supporting a timber plate. The exterior grade along the north side is about 1-foot below the top of the foundation wall. The exterior grade along the south side is approximately at the same elevation as the interior wood floor. Brick masonry cladding has been added along the outside face of the south wall in an attempt to provide some decay protection to the wall and timber sill. The top of this brick cladding is about 1-foot above the exterior grade and interior floor and covers decaying wall sheathing. (Images 1 – 5)

The first floor is framed with 2x4 joists spaced at 16" on center. The joists are supported on a 2x2 ledger fastened to 6x6 timber plates. The north exterior wall is constructed using board sheathing over 2x3 studs spaced at 39" on center. The south wall is constructed using plywood sheathing over 2x3 studs spaced at 16" on center with 4x4 post spaced at 4-feet on center. The majority of the roof is framed with boards spanning from the exterior walls to a 2x2 ridge. (Image 6)

The connector construction is haphazard, with a sloping floor, walls out of plumb, and techniques that would be considered unconventional for any time period. The brick masonry cladding wall does not provide sufficient or appropriate decay protection for the wood framing materials.



1-Connector north elevation



2-Connector south elevation



3-Connector brick cladding on south side



4-Connector inside face of brick cladding



5-Connector foundation on north side

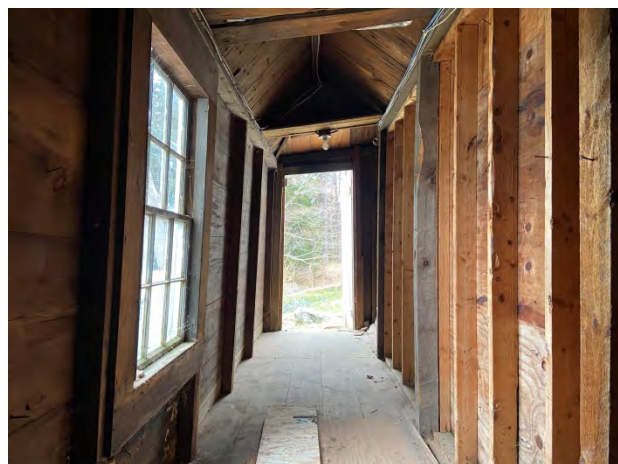

6-Connector interior looking east

2.0 Barn

The barn was originally constructed as a 12'-3"x40'-0" one story, wood framed structure with a mono-sloped roof. A renovation added the 10'-6"x16'-9" one story shed extension to the back of the building and created a 15'-5" wide door opening at the front elevation.



7-Barn southwest elevation



8-Barn north elevation



9-Siding extending below grade



10-Stone foundation along back of barn



11-Inside looking north



12-Inside looking south



13-5x5 timber supported on screw jack



14-Connector roof sheathing and purlins



15-Barn decay damage



16-Barn decay damage

The barn foundation along the front of the building is not accessible or visible. It is most likely constructed similar to the connector south wall, with brick cladding covering the base of the wood wall and the dry stacked stone foundation. At some locations along the front of the building, the soil is in contact with the wood clapboard siding and is above the interior floor elevation (Image 9). Along the back of the original building, the foundation is constructed of dry stacked stone (Image 10). At the addition, the foundation is constructed of concrete block and brick masonry.

The first floor is partially concrete slab, just within the sliding doors. (See SK-A) I believe the slab is cast directly on wood decking. The floor is wood decking on each side of the concrete slab. The exterior walls are framed with timber studs clad with pine board sheathing. The roof is framed with wood purlins supported by timber rafters.

The original barn timber frame was constructed using reasonably sized members and techniques. The renovation that added the shed extension, and the wide sliding doors along the front of the building, damaged and structurally degraded the original framing system. Much of the original front wall framing, including a frame supporting post on line-3, was removed to create the current door opening. (SK-A and SK-D) The original front wall frame posts on lines 2 and 4 have also been removed and replaced. Where the back wall of the original barn was removed, the existing and added framing has been supported by a heavily notched 5x5 timber and a screw jack. (Image 13) The purlins spanning from the barn to the carriage house are grossly undersized. (Image 14)

Barn Structural Analysis Summary

This analysis assumes members to be full dimension with the following design loads:

Roof framing analyzed for a 42 psf snow load plus a 20 psf dead load.

Floor framing analyzed for a 40 psf live load plus a 15 psf dead load.

Note: Structural components noted below are keyed on sketch SK-B

- Purlin P1** Assuming 3"x4" Hem-Fir, Select Structural, spaced at 2'-0" on center
Bending stress, fb = 1740 psi (exceeds allowable by 152%)
Total load deflection = 1.07" (exceeds allowable by 180%)
- Purlin P2** Assuming 4"x4" Hem-Fir, Select Structural, spaced at 3'-0" on center
Bending stress, fb = 1955 psi (exceeds allowable by 171%)
Total load deflection = 1.20" (exceeds allowable by 203%)
- Purlin P3** Assuming 2³/₄"x4" Hem-Fir, Select Structural, spaced at 3'-0" on center
Bending stress, fb = 5400 psi (exceeds allowable by 473%)
Total load deflection = 4.95" (exceeds allowable by 675%)
- Rafter R1** Assuming 8"x7" Eastern White Pine, Select Structural
Bending stress, fb = 1485 psi (exceeds allowable by 132%)
Total load deflection = 1.03" (exceeds allowable by 166%)
- Rafter R2** Assuming 6"x7" Eastern White Pine, Select Structural
Bending stress, fb = 2210 psi (exceeds allowable by 197%)
Total load deflection = 1.55" (exceeds allowable by 248%)
- Rafter R3** Assuming 7"x6" Eastern White Pine, Select Structural
Bending stress, fb = 2284 psi (exceeds allowable by 204%)
Total load deflection = 1.86" (exceeds allowable by 298%)
- Rafter R4** Assuming 7"x6" Eastern White Pine, Select Structural
Bending stress, fb = 2077 psi (exceeds allowable by 185%)
Total load deflection = 1.37" (exceeds allowable by 244%)

Please note that these calculations have ignored the effects of notches and other significant defects and damage in the wood framing. Including these issues in the analysis would significantly increase the member stresses resulting in even lower load capacities.

3.0 Carriage House

The carriage house was originally constructed as a 26'-3"x40'-6" story and a half timber frame hip-roofed structure. A subsequent renovation added a one story shed extension along the entire back of the building. (See image 17 and 18)



17-Carriage house east elevation



18-Carriage house northeast elevation

The carriage house is supported along the south wall, and most of the east wall, on a brick masonry foundation. The foundation wall along the south elevation retains approximately 5-feet of earth. At times during rain events water can be observed leaking through this wall onto the concrete floor slab. The balance of the foundation appears to be dry stacked stone piers.

The majority of the first floor is a concrete slab. About one-third of the floor area is wood decking supported on wood timbers on stone piers over soil. The second floor and roof of the carriage house is framed with wood timbers using deep cross-lap joints for connections. The roof is slate shingles on board sheathing. The clear headroom at the second floor level is about 5'-3". (1/SK-E)

The first floor exterior walls along the front and right sides are framed with conventional 2x stud framing, similar to what we might see today, with pine board sheathing. My opinion is that these walls may have been constructed in the 1960s to 70s timeframe. The original posts along the front wall have been cut down to fit within the newer stud walls, and it was observed that the bases of some of the posts have been repaired. (Images 19 and 20)



19-Brick foundation and front wall framing



20-Brick foundation and side wall framing

The structure has two major frames along lines 7 and 8 with steel hanger rods that extend from the second floor 8x8 carrying timber to the rafter peak. (See SK-B and SK-C) This system provides support to the second floor and relies on diagonal bracing at the second floor level and balloon posts that are continuous from the foundation to the roof truss. (See 1/SK-E) At the frame on line 7.5, the timber bottom chord was cut and removed. In an effort to compensate, 2x8 diagonal chords were installed in an attempt to create a scissor truss. (See images 21 & 22, and 2/SK-E)



21-Cut bottom chord on line 7.5



22-Modified roof framing at line 7.5



23-Modified framing to bridge over the removed post and wall at lower level



24-Vertical split at corner post

At the intersection of grid lines 8 and C, (SK-A) the balloon post was cut and removed at the first floor level. In an effort to compensate, truss-like diagonal framing was installed at the second floor wall along line C, to bridge over the removed post. (See image 23 and 3/SK-E)

Looking at the building from outside, it can be observed that there is significant distortion, or deflection, along the ridge, the hips and in the plane of the roof itself. Looking inside the building at the top of the corner post, we can observe the vertical split in the post where the hip rafter is being pushed outward. (See image 24)

Carriage House Structural Analysis Summary

This analysis assumes members to be full dimension with the following design loads:

Roof framing analyzed for a 42 psf snow load plus a 20 psf dead load.

Floor framing analyzed for a 40 psf live load plus a 15 psf dead load.

Note: Structural components noted below are keyed on sketch SK-B

Rafter R5 Assuming 3"x5" Hem-Fir, Select Structural, 2'-0" on center
 Bending stress, fb = 3525 psi (exceeds allowable by 330%)
 Total load deflection = 5.05" (exceeds allowable by 496%)

Joist J1 Assuming 7"x6" Hem-Fir, Select Structural, spaced at 3'-9" on center
 Bending stress, fb = 1730 psi (exceeds allowable by 144%)
 Total load deflection = 1.77" (exceeds allowable by 232%)

Carriage House Structural Analysis Summary - Continued

- Joist J2** Assuming 6"x6" Hem-Fir, Select Structural, spaced at 3'-9" on center
Bending stress, fb = 1200 psi (matches allowable stress of 1200 psi)
Total load deflection = 0.73" (exceeds allowable by 124%)
- Beam B1** Assuming 8"x8" Hem-Fir, Select Structural
Bending stress, fb = 2310 psi (exceeds allowable by 192%)
Total load deflection = 0.54" (within allowable)

Note: Structural components noted below are keyed on sketch SK-C

- Decking D1** Assuming 3/4" thick Hem Fir board sheathing
Bending stress, fb = 2070 psi (exceeds allowable by 160%)
Total load deflection = 1.73" (exceeds allowable by 525%)
- Purlin P4** Assuming 4"x2½" Red Oak, Grade #2
Bending stress, fb = 5920 psi (exceeds allowable by 430%)
Total load deflection = 4.6" (exceeds allowable by 525%)
- Rafter R6** Assuming 5"x7½" Hem Fir, Select Structural
Bending stress, fb = 2825 psi (exceeds allowable by 235%)
Total load deflection = 2.8" (exceeds allowable by 365%)
- Rafter R7** Assuming 5½"x5½" Hem Fir, Select Structural
Bending stress, fb = 2950 psi (exceeds allowable by 245%)
Total load deflection = 4.3" (exceeds allowable by 500%)
- Beam B2** Assuming 10"x8" Hem Fir, Select Structural
Bending stress, fb = 3002 psi (exceeds allowable by 250%)
Total load deflection = 5.6" (exceeds allowable by 440%)

Please note that these calculations have ignored the effects of notches and other significant defects and damage in the wood framing. Including these issues in the analysis would significantly increase the member stresses resulting in even lower load capacities.

Visual observations, along with the results of the engineering analysis, indicate that the carriage house structure is in very poor condition.

From outside the building, looking at the carriage house, one can observe significant distortion, which could be describe as a swayback condition, along the ridge, the hips, and roof planes. These distortions indicate that the building structure is significantly overstressed to levels that should be considered unacceptable. The results of basic engineering calculations, that should not be considered conservative, confirm that the buildings' member stresses and deflections are excessive.

In conclusion; any effort to renovate this existing building structure, for any type of occupancy, would be a difficult and expensive undertaking. In my opinion, every original structural member, including roof sheathing and all member connections, would need to be reinforced, repaired or replaced.

Thank you for this opportunity to be of service. Please feel free to contact me if there are any questions or if I may be of further service.

Respectfully submitted,
Martin Gorham, PE, LEED-AP, SECB

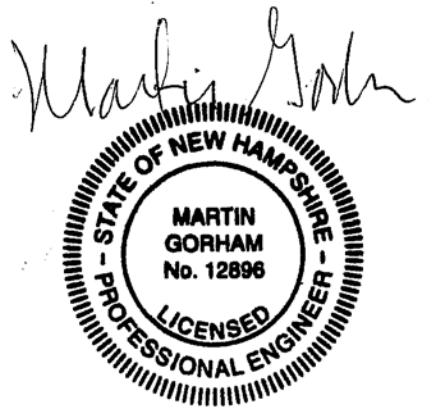

Attachments: SK-A, B, C, D & E

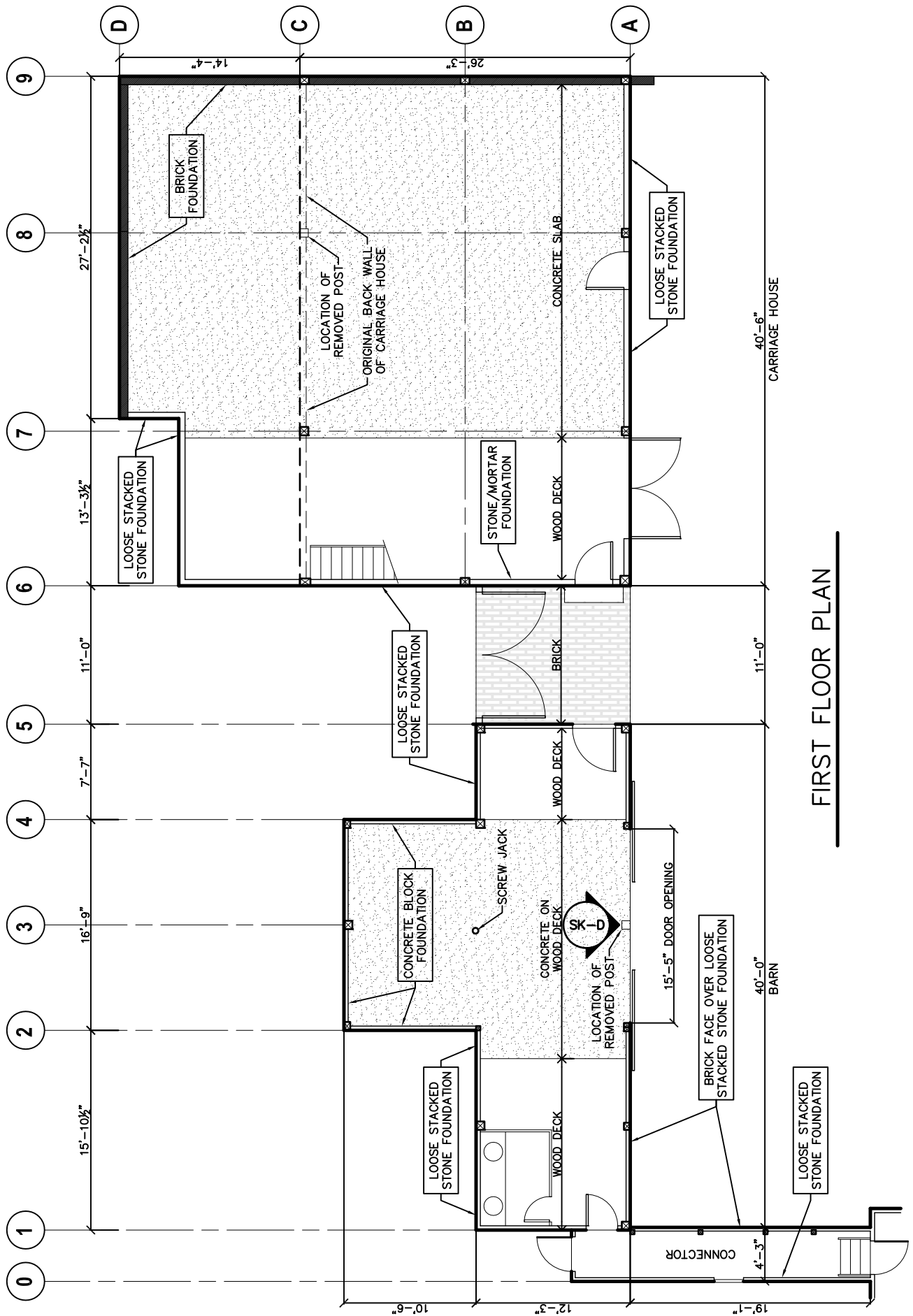

FIRST FLOOR PLAN

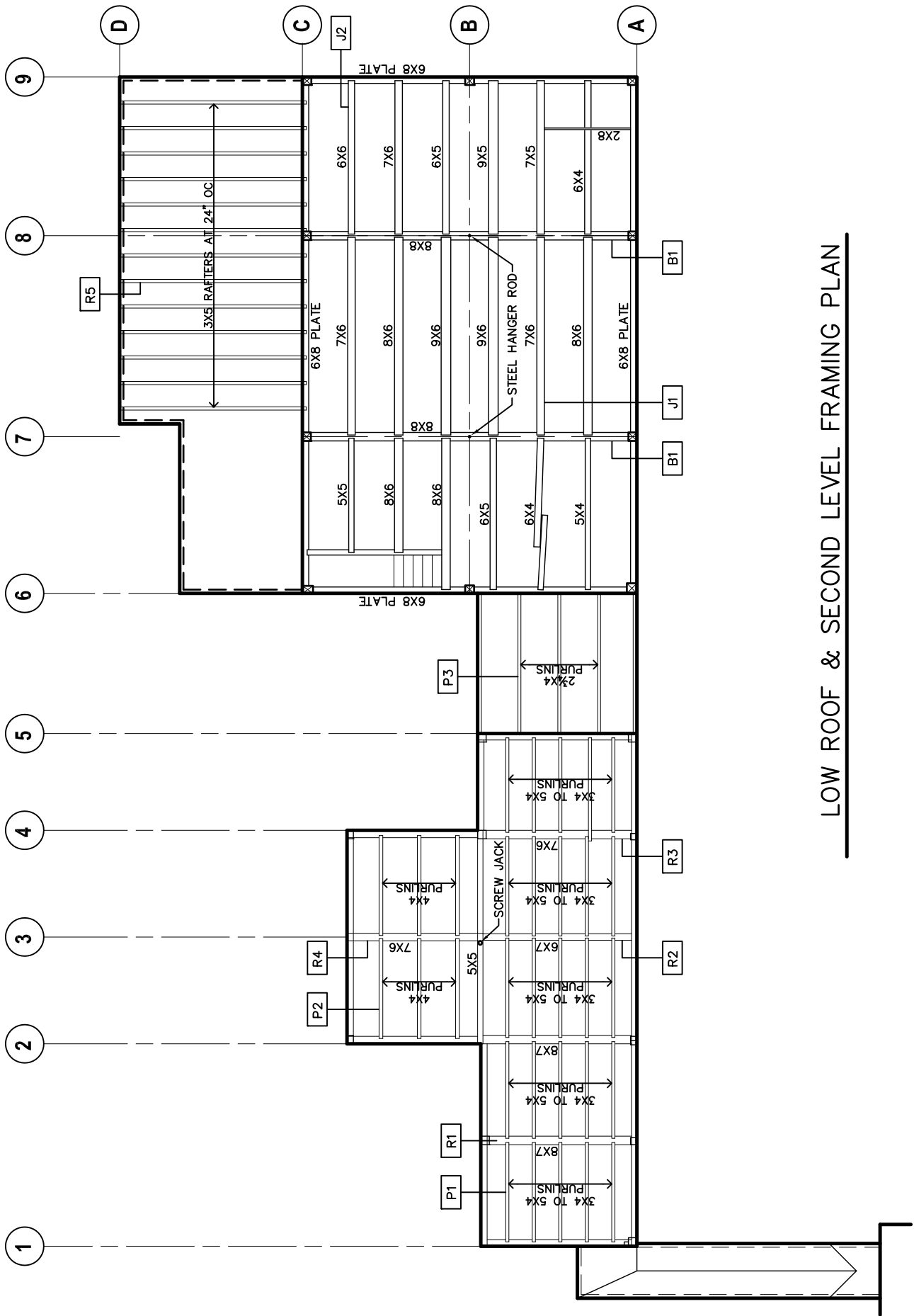

LOW ROOF & SECOND LEVEL FRAMING PLAN

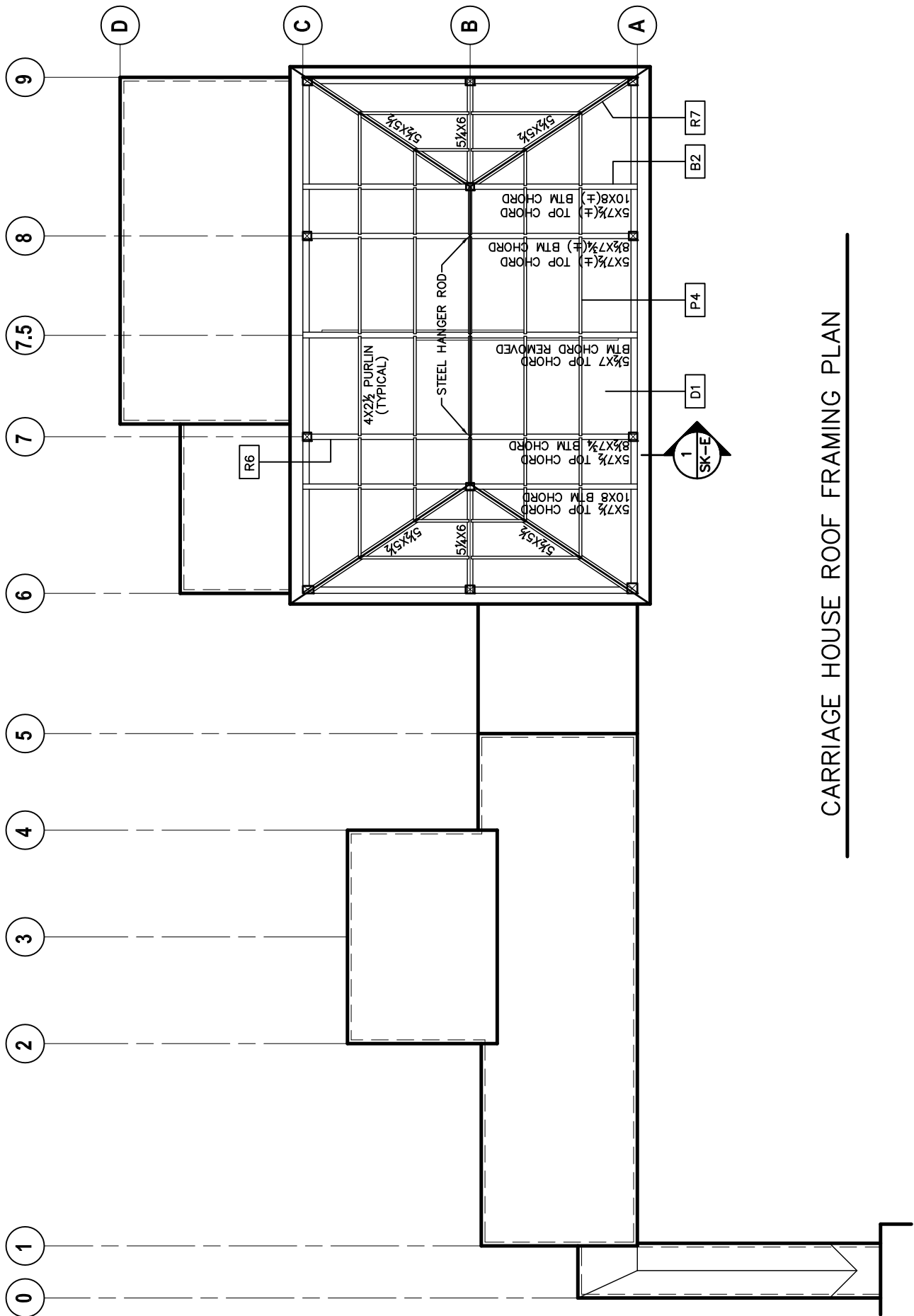

CARRIAGE HOUSE ROOF FRAMING PLAN

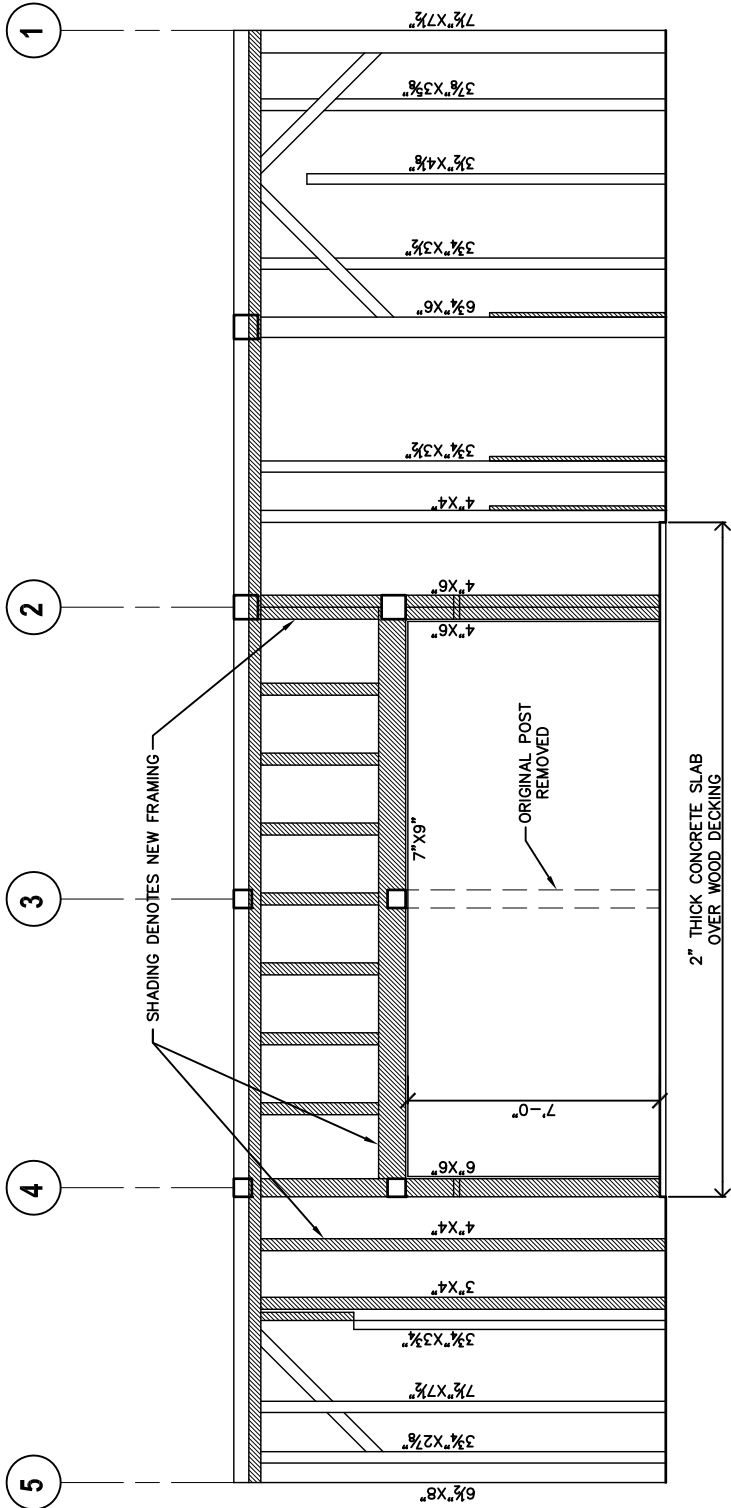

BARN FRONT WALL FRAMING ELEVATION – INSIDE VIEW

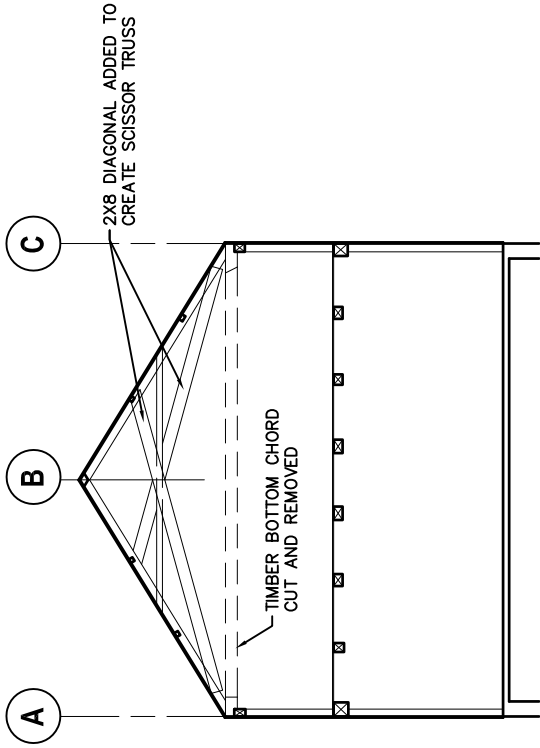

SECTION AT GRID 7.5

2
SK-E

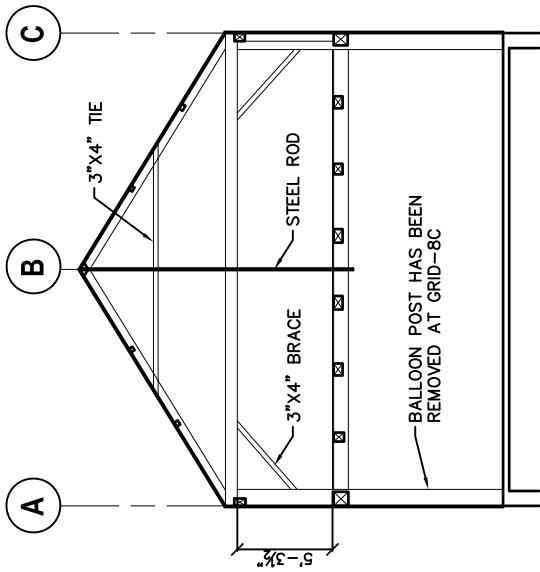

SECTION AT GRID 7 & 8

1
SK-E

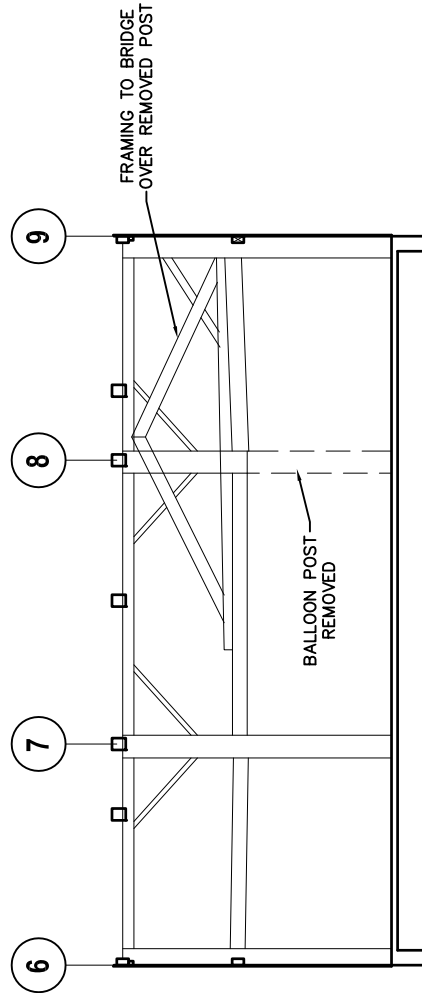

SECTION AT GRID C

3
SK-E

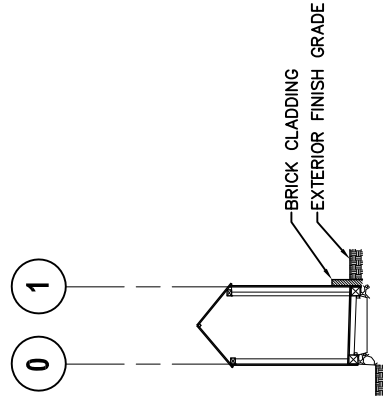

SECTION AT CONNECTOR

4
SK-E

Carriage House & Connector Buildings

Evaluation of Construction & Building Origin



The intent of this report is to provide background and clarity to the origin and dating of the carriage house and connecting structures at 179 Pleasant St. By reviewing construction methods, existing materials, historic maps, and consulting with industry professionals. We have generated this report for your review.

Dog Leg Connector:



Dog Leg Connector:

(Est Early 1900's)

The dog leg connector, much like the rest of the property has been subjected to a series of renovations over the years. Most of the framing members in the wall, floor, and roof systems have modern materials and certainly do not predate the early 1900's. The roofing material is slate; however, the flashing details are all modern materials and practices. The edge of the roof lines have metal drip edge installed, and the ridge cap detail is lead bent over the slate and does not match the hip or ridge detail of the mansion.

The front elevation exterior trim and clapboards have all been replaced and have no signs of original materials. The back elevation has older clapboards installed on a portion of the wall system. The clapboards have a very steep lap joint that overlaps by roughly 2". This indicates older siding practice and thus older material. The nails used to secure the siding and the steep lap joints however, do not match the siding details on the mansion. This suggests a different period for the installation of the siding on the dog leg connector.

Another key detail is how the dog leg connector butts into the annex and barn/connector. The corner boards and fascia are cut into the other structures and in some points scribed around the other structures. Again, this suggests that this building postdates the annex and even the barn/connector.

Barn/Connector:



Barn/Connector:

(Est 1890 – Early 1900's)

The barn/main connecting structure also exhibits signs of significant renovation work over the years. Through our research we know that the front wall was reframed to accommodate a larger sliding door in 2018. A 10' x 16' "carport" was added to the back side of the structure in 1979. In reviewing the framing most of the front wall has been removed and replaced with rough sawn material to accommodate the door renovation in 2018. Additionally, most of the roof framing was cut and altered to accommodate the carport addition in 1979.

We noticed a unique difference between the roof framing in the barn/connector and the carriage house and mansion. The barn/connector roof system is a timber frame just like the mansion and carriage house. It has main rafters, purlins, and wind or corner bracing into the king posts. The joinery of the wind or corner bracing was mortised into the side of the king post and rafter, and then secured with a large steel nail. The mansion and carriage house all have mortise pockets and tenon joints with a wooden peg. This could be a result of the roof being altered and repurposed to accommodate the various renovations, or the different framing style may suggest a different period for the structure.

There is little to extract from the exterior details on this structure. Most of the siding and exterior trim has been replaced or is rotted beyond any repair. The exterior wall facing the carriage house located under the open roof system is however intact. The siding on this wall has a but joints and no noticeable nail heads like the mansion.

Carriage House:



Carriage House:

(Est 1784)

The carriage house is the only structure (outside of the mansion) that still has elements of its 1784 origin. Unfortunately, the carriage house has suffered the greatest impact from haphazard renovations and poor construction practices out of all the structures on the property.

In 1962 the carriage house underwent an extensive renovation to accommodate a dentist office. The renovation basically removed the entire first floor walls and floor systems. There are almost no original materials left on the first floor of the carriage house to include, wall studs, sheathing, windows, doors, siding, trim, foundation. I believe they systematically removed sections of the walls while they reframed and eventually poured a concrete slab throughout most of the carriage house.

The second floor and roof system however have remained mostly intact and original to the 1784 period. The massing of the beams, the joinery methods, and the framing layouts all match the mansion framing. Some of the beams have been cut or notched over the years but for the most part the framing is intact.

There are (2) single story additions off the back of the carriage house. These two structures are not original to the carriage house, and we believe were most likely added in the late 1800's or early 1900's with the barn/connector. The framing members used are machined and the framing practice mimics that of the annex and a balloon frame style. The roof rafters of these additions are also notched into the second-floor sheathing of the carriage house.



Conclusion:

After reviewing the connecting structures and carriage house as well as consulting with other professionals, it is our opinion the mansion and carriage house are the only structures original to the 1784 period. We believe the original property encompassed the mansion, a small kitchen "L" off the back of the mansion and the carriage house.

We also believe the barn/connector was added sometime after 1860 when Mark Wentworth purchased the property. We have found news papers in the mansion used as insulation and vapor barrier which suggest the renovation occurred closer to 1889 -1890. It is my opinion that Mark Wentworth renovated the mansion and added the barn/connector onto the carriage house at this time.

The dog leg connector and single story additions on the back of the carriage house we believe occurred sometime after the barn/connector and mansion renovation. Mark Wentworth passed away leaving the property to his daughter Susan Wentworth in 1903. We believe Susan added the back additions and the dog leg connector sometime during her ownership of 1903-1940. New Additions, Renovations, and Repurposing of materials has been ongoing to present day.