

AMBIT ENGINEERING, INC. CIVIL ENGINEERS AND LAND SURVEYORS
200 Griffin Road, Unit 3, Portsmouth, NH 03801
Phone (603) 430-9282 Fax 436-2315

20 December 2020

Dexter Legg, Chair
City of Portsmouth Planning Board
1 Junkins Avenue
Portsmouth, NH 03801

**Re: City of Portsmouth Wetland Conditional Use Permit Request
Tax Map 111, Lot 2
232-234 South Street
Portsmouth, New Hampshire**

Dear Chairman Legg and Planning Board Members:

This letter transmits a City of Portsmouth Wetland Conditional Use Permit request for 636 square feet of disturbance within the 100' City of Portsmouth Wetland Buffer for the construction of an addition, new deck, and staircase onto the existing residential structure, and 262 sq. ft of disturbance for the relocation of an existing storage shed and subsequent proposed buffer enhancements consisting of installation of native plantings.

The property currently contains a two-unit residential structure, two wooden decks, a covered porch, paved driveway areas, a storage shed, stairs for access/egress, and associated landscaping.

The proposed deck includes a crushed stone drip apron underneath to allow for collection and infiltration of the stormwater from the proposed deck.

According to the City of Portsmouth Zoning Ordinance, *Article 10.1017.50 Criteria for Approval*, the proposal shall comply with the following criteria:

1. The land is reasonably suited to the use, activity or alteration.

The proposal is to construct an addition, new deck, and staircase onto the existing residential structure. Only a very small portion of the proposed addition is located within the 100' Wetland Buffer, with a majority of the disturbance area attributed to the proposed deck and stair access. The proposed area of disturbance is located in an area that would be characterized as maintained lawn and does not require the removal of any naturally vegetated buffer area to achieve construction goals. Given that the proposed project would occur in an area characterized as maintained lawn, and the construction is associated with an existing structure, the land is reasonably suited to the use, activity, or alteration. The addition is needed to update the access as required for life and safety codes in a reasonable manner.

2. There is no alternative location outside of the wetland buffer that is feasible and reasonable for the proposed use, activity or alteration.

Due to the configuration of the lot, and location of nearby wetlands, there does not exist an area to propose the site improvements while avoiding the 100' City of Portsmouth Wetland Buffer. The proposed addition has been architecturally designed to fit into a space, be joined with the existing structure, and be mostly located outside of the wetland buffer. The proposed deck provides the property with an outdoor space, but also maintains privacy for the occupants and the abutters, as neighboring properties have similar accessory structures. The proposed stairs and staircase simply provide the residential structure with a means of safe access/egress. The relocated shed has been placed as far from the buffer as reasonable.

3. There will be no adverse impact on the wetland functional values of the site or surrounding properties.

The proposal will not impact the existing wetland resource located adjacent to the site and its current functions and values. The proposed crushed stone drip apron underneath the deck, and the relocation of the existing storage shed, combined with a buffer enhancement plantings will improve stormwater quality, treatment, and infiltration within the 100' City of Portsmouth Wetland Buffer. It is our belief that the above project will improve water quality entering the nearby wetland resource, and therefore have no adverse impact on the wetland functional values and the surrounding properties.

4. Alteration of the natural vegetative state or managed woodland will occur only to the extent necessary to achieve construction goals.

The areas within the 100' City of Portsmouth Wetland Buffer that are proposed to be impacted would be characterized as existing maintained lawn. There will be no alteration of the natural vegetated state to achieve construction goals. The addition is modest and is in keeping with developed adjacent properties.

5. The proposal is the alternative with the least adverse impact to areas and environments under the jurisdiction of this Section.

The project represents the alternative with the least adverse impacts to areas and environments while allowing reasonable use of the property. The proposal impacts areas that would be characterized as maintained lawn, removes a storage shed located approximately 35 feet from the wetland boundary, and provides a buffer enhancement plan.

6. Any area within the vegetated buffer strip will be returned to a natural state to the extent feasible.

The area where the shed is removed, which is within the vegetated buffer strip, will be returned to a natural vegetated state by this project.

Please contact me if you have any questions or concerns regarding this application.

Respectfully submitted,

John Chagnon

John R. Chagnon, PE; Project Manager

Technical assistance provided by:

Steven D. Riker; NH Certified Wetland Scientist/Environmental Permitting Specialist
Ambit Engineering, Inc.

Cc: JJCM Realty LLC & Top Notch Properties LLC-Owners/Applicants

Return to:
JJCM Realty LLC
23 Whittemore Street
Bedford, NH 03110



LCHIP	ROA529242	25.00
TRANSFER TAX	RO102003	6,000.00
RECORDING		14.00
SURCHARGE		2.00

T.S. \$6,000.00

WARRANTY DEED

KNOW ALL MEN BY THESE PRESENTS: That **Old College Holdings LLC**, a New Hampshire Limited Liability Company, of 392 Maple Street, Andover, NH 03216, for consideration paid grant(s) to **JJCM Realty LLC**, a New Hampshire Limited Liability Company, of 23 Whittemore Street, Bedford, NH 03110 and **Topnotch Properties LLC**, a New Hampshire Limited Liability Company, of 9 Pasture Lane, Bedford, NH 03110, with WARRANTY COVENANTS:

Property Reference: 232 South Street, Portsmouth, Rockingham County, New Hampshire

A certain lot or parcel of land with the buildings thereon situate upon South Street in said Portsmouth and known as #232 and #234 upon said South Street bounded and described as follows:

Northerly by land of May Belle Dame one hundred twenty-six and five tenths (126.5) feet;
Easterly by and now or formerly of Rienza Ridge sixty-two and three tenths (62.3) feet;
Southerly by land of John Tibbetts one hundred twenty-one and five tenths (121.5) feet and
Westerly by said South Street sixty-two and one tenth (62.1) feet.

Meaning and intending to describe and convey the same premises conveyed to Old College Holdings LLC by Warranty Deed from James Marchese, Trustee of the Vincent A. Marchese, Jr., Revocable Trust as recorded on October 1, 2020 in the Rockingham County Registry of Deeds at Book 6172, Page 1456.

The property is not subject to homestead rights.

Executed this 20th day of November, 2020.

Old College Holdings LLC



By: Brendaen Makechnie
Its duly authorized Manager

State of New Hampshire
County of Hillsborough

November 20, 2020

Then personally appeared before me on this 20th day of November, 2020, Brendaen Makechnie, duly authorized Manager of Old College Holdings LLC, proved to me through satisfactory evidence of identification, which was his drivers license to be the person whose name is signed on the preceding or attached document, and acknowledged to me that he is duly authorized to sign on behalf of the company, and signed it as his free and voluntary act for the purposes stated herein on the company's behalf.

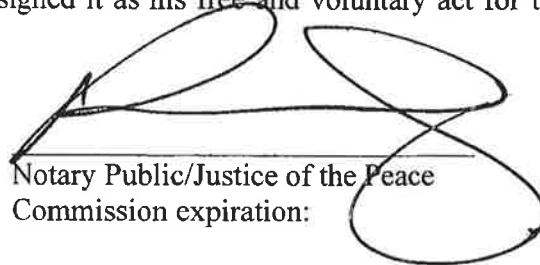

Notary Public/Justice of the Peace
Commission expiration:

PAUL C. ENGLISH
Notary Public - New Hampshire
My Commission Expires May 4, 2021

Site Photograph #1

October 2020



Site Photograph #2

October 2020



Site Photograph #3

October 2020



Site Photograph #4

October 2020



**STORMWATER MANAGEMENT
INSPECTION & MAINTENANCE PLAN**
FOR
JJCM Realty LLC & Top Notch Properties LLC
PROPERTY LOCATED AT
232-234 South Street Portsmouth, NH
December 20, 2020

Introduction

The intent of this plan is to provide JJCM Realty LLC & Top Notch Properties LLC, owners of property located at 232-234 South Street, Portsmouth, NH, with a list of procedures that cover the inspection and maintenance requirements of the stormwater management structures for the proposed construction at the site.

The following inspection and maintenance program is necessary to keep the stormwater management structures functioning properly. These measures will also help minimize potential environmental impacts. By following the enclosed procedures, JJCM Realty LLC & Top Notch Properties LLC will be able to maintain the functional design of the stormwater management structures and maximize its ability to remove sediment and other contaminants from site generated stormwater runoff.

Stormwater Management System Components

The Stormwater Management System design components are a Stone Drip Apron, and a Buffer Planting Area.

The proposed construction includes construction of an addition, new deck, and staircase onto the existing residential structure, and 262 sq. ft of disturbance for the relocation of an existing storage shed and a proposed buffer enhancement area consisting of installation of native plantings. Since a portion of the proposed construction is within the City of Portsmouth's wetland buffer zone, the proposed stormwater structures will provide treatment for the proposed improvements, as well as some of the existing features, under the application.

The Stone Drip Apron underneath the proposed deck will capture runoff from the proposed deck and provide storage and percolation into the soil below. The buffer planting area will enhance the

existing naturally vegetated buffer providing for increased nutrient removal and improved stormwater quality entering the nearby wetland resource.

Inspection & Maintenance Checklist/Log

The following pages contain maintenance specifications, a Stormwater Management System Inspection & Maintenance Checklist, and a blank copy of the Stormwater Management System Inspection & Maintenance Log. The forms are provided to JJCM Realty LLC & Top Notch Properties LLC and should be transferred to future homeowners and will serve as a guideline for performing the inspection and maintenance of the Stormwater Management System. This is a guideline and should be periodically reviewed for conformance with current practice and standards.

Stone Drip Apron Design

The intent of the stone drip apron is to provide for storage and percolation of runoff from the proposed deck. Stone Drip Aprons are meant to provide a porous medium (stone, 6" depth) that can withstand water velocity from the structure above, eliminating erosion at the point of contact. The base (24"-36" depth) of the drip edge is backfilled with coarse sand or gravel which allows the stormwater to quickly infiltrate into the ground where it is stored and slowly percolated into the surrounding subsoil. The Stone Drip Apron will extend from the foundation edge slightly further than the structure above to effectively capture runoff from the structure above, in this case a wooden deck.

Stone Drip Apron Maintenance

In order to keep the Stone Drip Aprons functioning properly, it is important to keep the filter surface porous and unplugged by debris.

Remove any debris that may clog the stone surface.

After leaf fall (i.e. in November), remove large accumulations of leaves. It is not necessary to remove every leaf but at the same time it is not desirable to have the stone surface completely covered with leaves to the point of plugging the stone surface.

Replace the stone surface with new stone as needed. If it is observed that water is ponding or percolating through the stone media very slowly, the stone surface and underlying coarse sand/gravel backfill base will need to be replaced as it is likely clogged from accumulating debris.

Buffer Planting Area Design

The intent of the buffer planting area is to provide a vegetative matrix that will aid in the filtering of nutrients, sediments, and toxicants before they enter an adjacent wetland resource. Root structures of the native plants not only provide excellent stabilization for the surrounding soils, but also provide a natural filtration mechanism for stormwater as it passes through the buffer planting area. The buffer planting area will be planted with native shrubs, herbs, grasses, and also includes an invasive species removal component.

Buffer Planting Area Maintenance

Planting and landscaping (shrubs, herbs, grasses) shall be monitored bi-monthly during the first year to insure viability and vigorous growth. Replace dead or dying vegetation with new stock and make adjustments to the conditions that caused the dead or dying vegetation. Make the necessary adjustments to ensure long-term health of the vegetated covers, i.e. provide more permanent mulch or compost or other means of protection. Also monitor the buffer planting area for signs of invasive species growth. The buffer planting area should not be mowed and allowed to grow naturally, increasing its function.

Invasive Species

Monitor the buffer planting area for signs of invasive species growth. If caught early enough, their eradication is much easier. The most likely places where invasions start are in wetter, disturbed soils. Species such as phragmites and purple loose-strife are common invaders in the wetter areas. Young shoots of invasive species can physically be pulled by hand as a method of control. The vegetated swale and rain garden should be inspected monthly during the growing season for the presence of invasive species.

Stormwater Management System
 JJCM Realty LLC & Top Notch Properties LLC
 232 – 234 South Street, Portsmouth, NH

Inspection & Maintenance Checklist

BMP/System Component	Minimum Inspection Frequency	Minimum Inspection Requirements	Maintenance/Cleanout Threshold
Stone Drip Apron	Twice Yearly	Remove leaves / debris from surface	Clean and/or replace stone as needed

Buffer Planting Area	Routinely after heavy rain	Inspect for damage and erosion	Replace top soil and seed as needed
Buffer Planting Area	Bi-Monthly during first growing season (Apr-Oct)	Inspect for viability and growth	Replace dead or dying plants with new stock. Make adjustments to conditions to promote plant growth
Buffer Planting Area	Monthly during growing season (Apr-Oct)	Inspect for invasive species	Pull young shoots by hand and dispose in household trash bags

Stormwater Management System
JJCM Realty LLC & Top Notch Properties LLC
232 – 234 South Street, Portsmouth, NH

Inspection & Maintenance Log

BMP/System Component	Date Inspected	Inspector	Cleaning/Repair Needed <i>(List Items/Comments)</i>	Date of Cleaning/Repair	Performed By

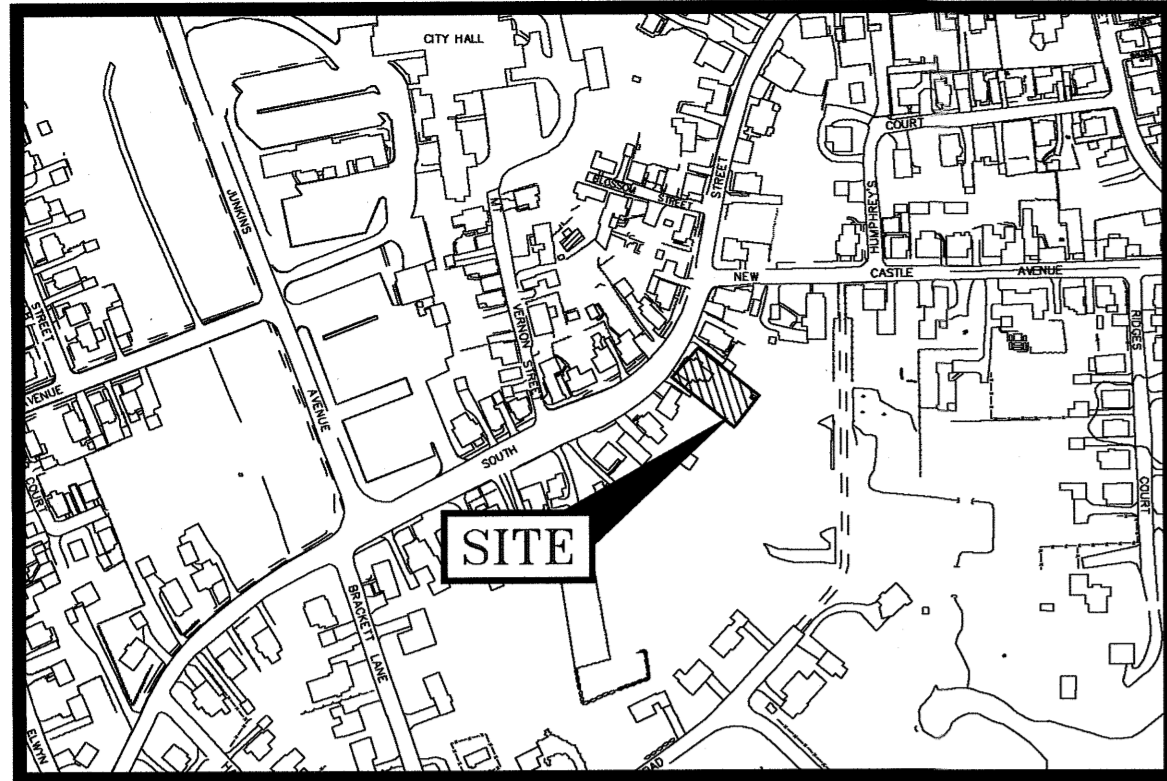

LOCATION MAP SCALE: 1" = 300'

LEGEND:

- N/F NOW OR FORMERLY
- RP RECORD OF PROBATE
- RCRD ROCKINGHAM COUNTY
- RR SPK RAILROAD SPIKE
- MAP 11/LOT 21
- IR FND IRON ROD FOUND
- IP FND IRON PIPE FOUND
- IR SET IRON ROD SET
- DH FND DRILL HOLE FOUND
- DH SET DRILL HOLE SET
- NHNB NHDOT BOUND FOUND
- TB TOWN BOUND
- BND w/DH BOUND WITH DRILL HOLE
- ST BND w/DH STONE BOUND WITH DRILL HOLE

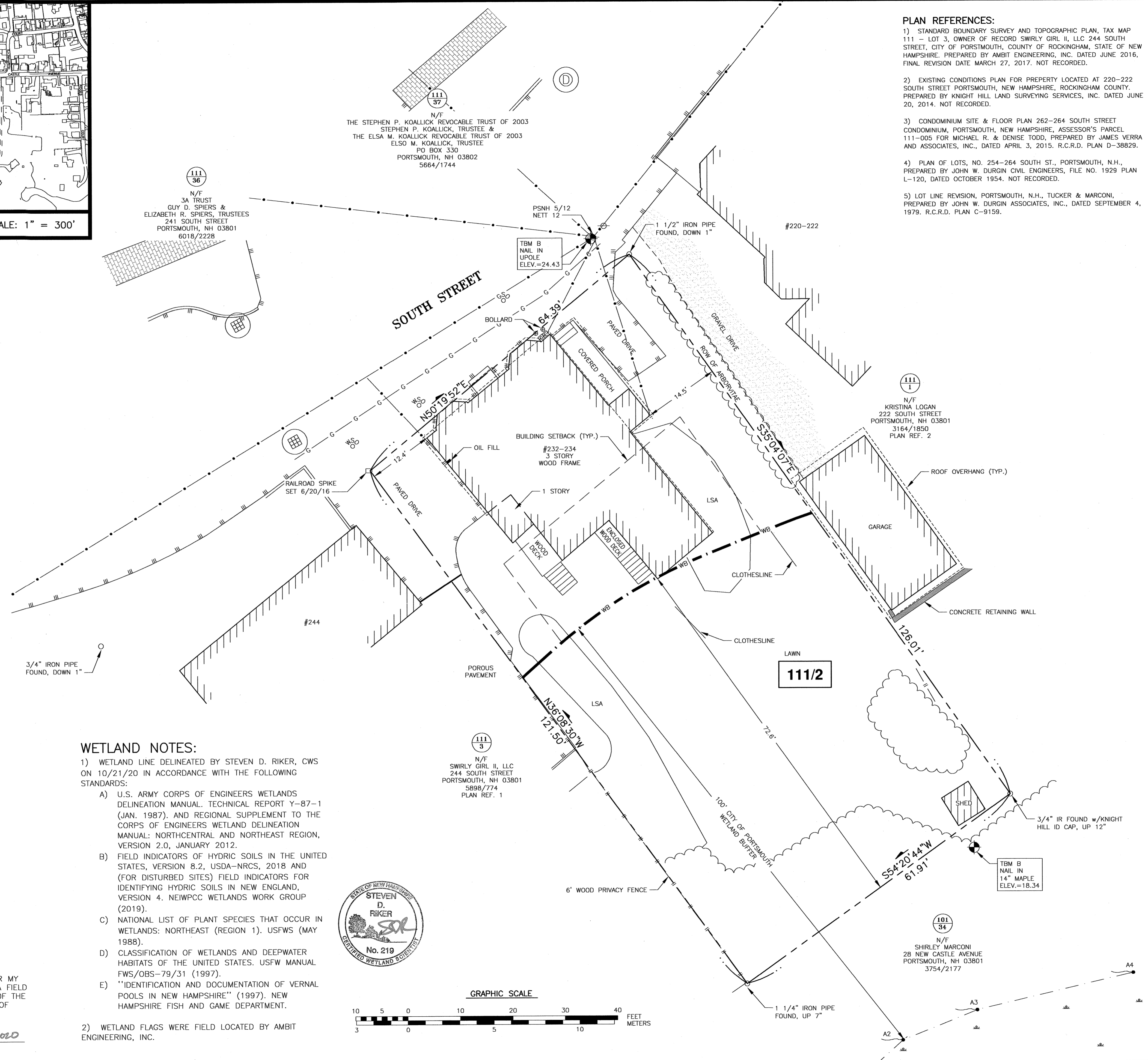

- PLAN REFERENCES:
- STANDARD BOUNDARY SURVEY AND TOPOGRAPHIC PLAN, TAX MAP 111 - LOT 3, OWNER OF RECORD SWIRLY GIRL II, LLC 244 SOUTH STREET, CITY OF PORTSMOUTH, COUNTY OF ROCKINGHAM, STATE OF NEW HAMPSHIRE. PREPARED BY AMBIT ENGINEERING, INC. DATED JUNE 2016, FINAL REVISION DATE MARCH 27, 2017. NOT RECORDED.
 - EXISTING CONDITIONS PLAN FOR PROPERTY LOCATED AT 220-222 SOUTH STREET PORTSMOUTH, NEW HAMPSHIRE, ROCKINGHAM COUNTY. PREPARED BY KNIGHT HILL LAND SURVEYING SERVICES, INC. DATED JUNE 20, 2014. NOT RECORDED.
 - CONDOMINIUM SITE & FLOOR PLAN 262-264 SOUTH STREET CONDOMINIUM, PORTSMOUTH, NEW HAMPSHIRE, ASSESSOR'S PARCEL 111-005 FOR MICHAEL R. & DENISE TODD, PREPARED BY JAMES VERRA AND ASSOCIATES, INC., DATED APRIL 3, 2015. R.C.R.D. PLAN D-38829.
 - PLAN OF LOTS, NO. 254-264 SOUTH ST., PORTSMOUTH, N.H., PREPARED BY JOHN W. DURGIN CIVIL ENGINEERS, FILE NO. 1929 PLAN L-120, DATED OCTOBER 1954. NOT RECORDED.
 - LOT LINE REVISION, PORTSMOUTH, N.H., TUCKER & MARCONI, PREPARED BY JOHN W. DURGIN ASSOCIATES, INC., DATED SEPTEMBER 4, 1979. R.C.R.D. PLAN C-9159.

AMBIT ENGINEERING, INC.
Civil Engineers & Land Surveyors
200 Griffin Road - Unit 3
Portsmouth, N.H. 03801-7114
Tel (603) 430-9282
Fax (603) 436-2315

- NOTES:
- PARCEL IS SHOWN ON THE CITY OF PORTSMOUTH ASSESSOR'S MAP 111 AS LOT 2.
 - OWNER OF RECORD:
JCM REALTY, LLC & TOP NOTCH PROPERTIES, LLC
9 PASTURE LANE
BEDFORD, NH 03110
6198/478
 - PARCEL IS NOT IN A SPECIAL FLOOD HAZARD AREA AS SHOWN ON FIRM PANEL 33015C0259E. EFFECTIVE DATE MAY 17, 2005.
 - EXISTING LOT AREA:
7,805 S.F.
0.1792 ACRES
 - PARCEL IS LOCATED IN THE SINGLE RESIDENCE B (SRB) ZONING DISTRICT.
 - DIMENSIONAL REQUIREMENTS:
MIN. LOT AREA: 15,000 S.F.
FRONTAGE: 100 FEET
SETBACKS: FRONT 30 FEET
SIDE 10 FEET
REAR 30 FEET
MAXIMUM STRUCTURE HEIGHT: 35 FEET
MAXIMUM BUILDING COVERAGE: 20%
MINIMUM OPEN SPACE: 40%
 - THE PURPOSE OF THIS PLAN IS TO SHOW THE RESULTS OF A STANDARD BOUNDARY SURVEY OF ASSESSOR'S MAP 111 LOT 2 IN THE CITY OF PORTSMOUTH.

- WETLAND NOTES:
- WETLAND LINE DELINEATED BY STEVEN D. RIKER, CWS ON 10/21/20 IN ACCORDANCE WITH THE FOLLOWING STANDARDS:
 - U.S. ARMY CORPS OF ENGINEERS WETLANDS DELINEATION MANUAL, TECHNICAL REPORT Y-87-1 (JAN. 1987), AND REGIONAL SUPPLEMENT TO THE CORPS OF ENGINEERS WETLAND DELINEATION MANUAL: NORTHCENTRAL AND NORTHEAST REGION, VERSION 2.0, JANUARY 2012.
 - FIELD INDICATORS OF HYDRIC SOILS IN THE UNITED STATES, VERSION 8.2, USDA-NRCS, 2018 AND (FOR DISTURBED SITES) FIELD INDICATORS FOR IDENTIFYING HYDRIC SOILS IN NEW ENGLAND, VERSION 4. NEWPCC WETLANDS WORK GROUP (2019).
 - NATIONAL LIST OF PLANT SPECIES THAT OCCUR IN WETLANDS: NORTHEAST (REGION 1). USFWS (MAY 1988).
 - CLASSIFICATION OF WETLANDS AND DEEPWATER HABITATS OF THE UNITED STATES. USFWS MANUAL FWS/OBS-79/31 (1997).
 - "IDENTIFICATION AND DOCUMENTATION OF VERNAL POOLS IN NEW HAMPSHIRE" (1997). NEW HAMPSHIRE FISH AND GAME DEPARTMENT.
 - WETLAND FLAGS WERE FIELD LOCATED BY AMBIT ENGINEERING, INC.

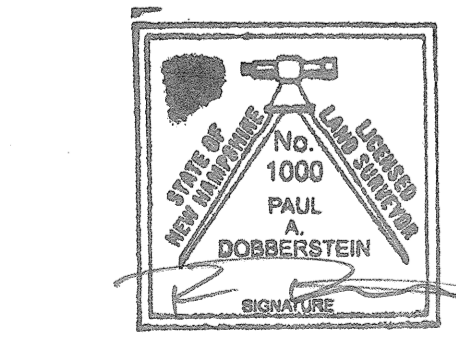
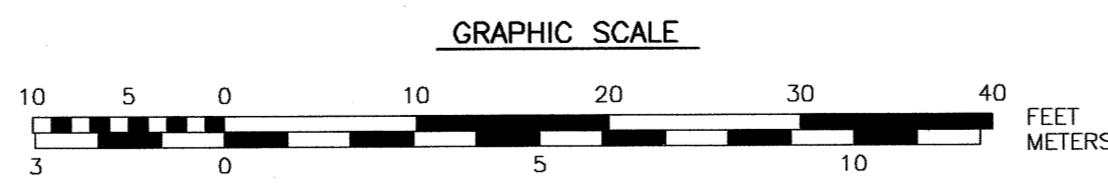

"I CERTIFY THAT THIS PLAN WAS PREPARED UNDER MY DIRECT SUPERVISION, THAT IT IS THE RESULT OF A FIELD SURVEY BY THIS OFFICE AND HAS AN ACCURACY OF THE CLOSED TRAVERSE THAT EXCEEDS THE PRECISION OF 1:15,000."
PAUL A. DOBBERSTEIN, LLS
DATE: 12/14/2020

NO.	DESCRIPTION	DATE
0	ISSUED FOR COMMENT	12/11/20

STANDARD BOUNDARY SURVEY
TAX MAP 111 - LOT 2
OWNERS:
JCM REALTY, LLC &
TOP NOTCH PROPERTIES, LLC

PROPERTY LOCATED AT:
232-234 SOUTH STREET
CITY OF PORTSMOUTH
COUNTY OF ROCKINGHAM
STATE OF NEW HAMPSHIRE
SCALE: 1" = 10'
DECEMBER 2020

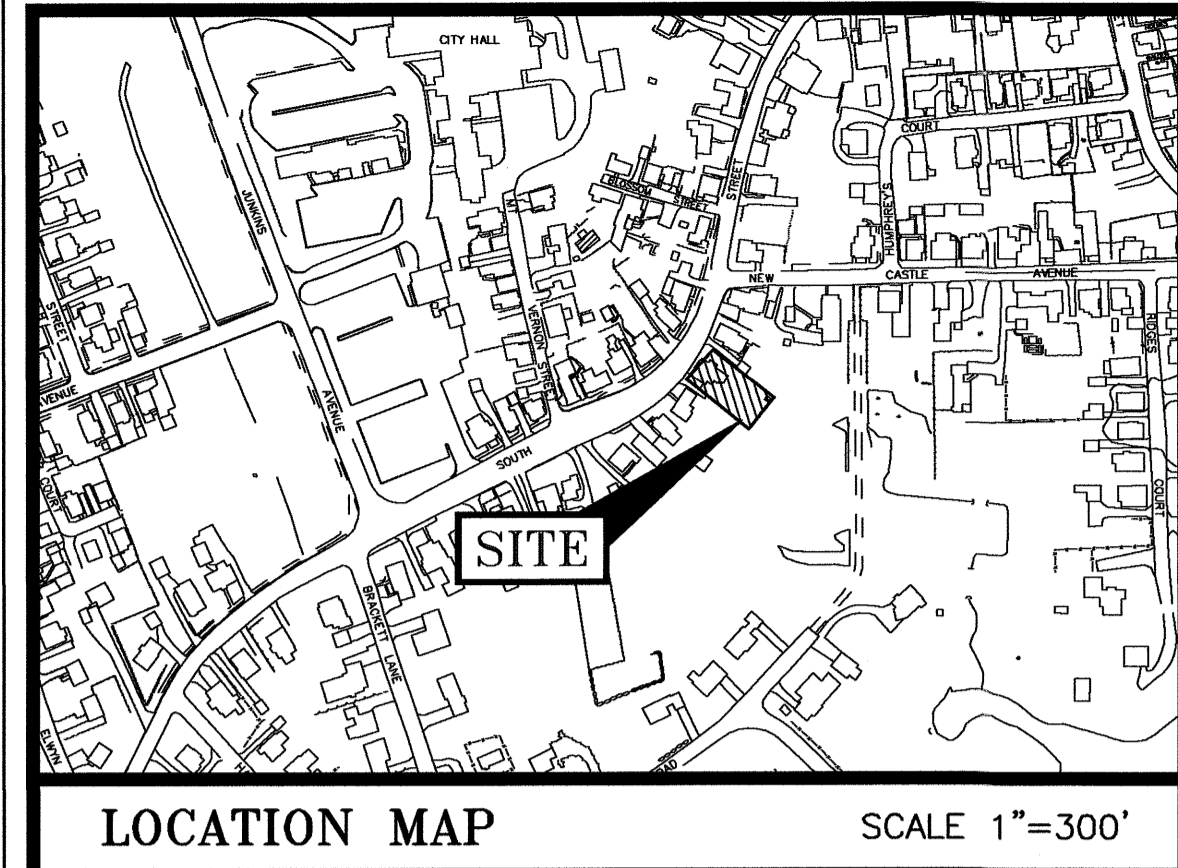

LOCATION MAP SCALE 1"=300'

LEGEND:

- N/F NOW OR FORMERLY
- RP RECORD OF PROBATE
- RCRD ROCKINGHAM COUNTY REGISTRY OF DEEDS
- MAP 11 / LOT 21
- BOUNDARY
- SETBACK
- RAILROAD SPIKE FOUND
- IRON ROD/PIPE FOUND
- DRILL HOLE FOUND
- STONE/CONCRETE BOUND FOUND
- RAILROAD SPIKE SET
- IRON ROD SET
- DRILL HOLE SET
- GRANITE BOUND SET
- EDGE OF PAVEMENT (EP)
- WOODS / TREE LINE
- UTILITY POLE (w/ GUY)
- METER (GAS, WATER, ELECTRIC)
- TYP. TYPICAL
- LSA LANDSCAPED AREA
- OVERHEAD ELECTRIC/WIRES

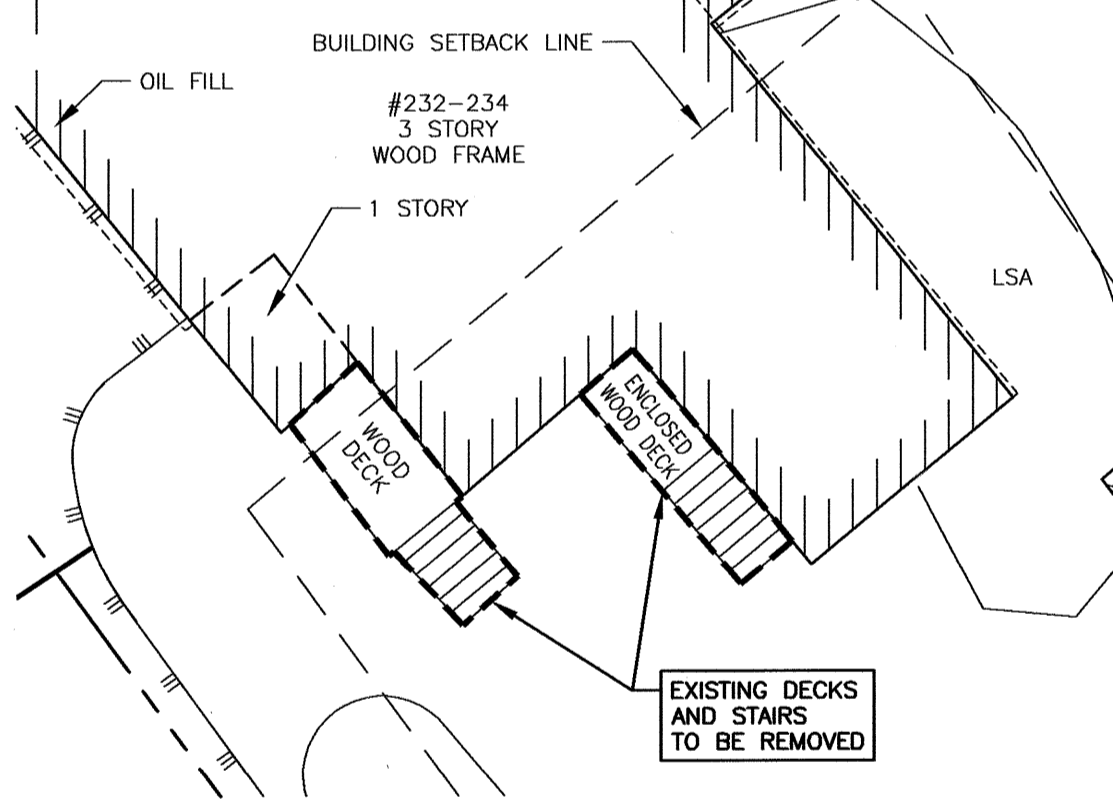

SITE DEMOLITION

IMPERVIOUS SURFACE AREAS

(TO PROPERTY LINE)

STRUCTURE	PRE-CONSTRUCTION IMPERVIOUS (S.F.)	POST-CONSTRUCTION IMPERVIOUS (S.F.)
MAIN STRUCTURE	1,272	1,469
PORCHES	75	75
SHED	37	37
DECKS	66	142
PAVEMENT	506	506
PATIO	0	0
STAIRS	68	65
WALKWAYS	0	322
TOTAL	2024	2616
LOT SIZE	7,805	7,805
% LOT COVERAGE	25.9%	33.5%

"I CERTIFY THAT THIS PLAN WAS PREPARED UNDER MY DIRECT SUPERVISION, THAT IT IS THE RESULT OF A FIELD SURVEY BY THIS OFFICE AND HAS AN ACCURACY OF THE CLOSED TRAVERSE THAT EXCEEDS THE PRECISION OF 1:15,000."

PAUL A DOBBERSTEIN, LLS DATE

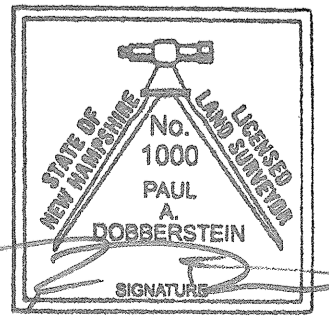

WETLAND NOTES:

- 1) WETLAND LINE DELINEATED BY STEVEN D. RIKER, CWS ON 10/21/20 IN ACCORDANCE WITH THE FOLLOWING STANDARDS:
 - A) U.S. ARMY CORPS OF ENGINEERS WETLANDS DELINEATION MANUAL, TECHNICAL REPORT Y-87-1 (JAN. 1987), AND REGIONAL SUPPLEMENT TO THE CORPS OF ENGINEERS WETLAND DELINEATION MANUAL: NORTH-CENTRAL AND NORTHEAST REGION, VERSION 2.0, JANUARY 2012.
 - B) FIELD INDICATORS OF HYDRIC SOILS IN THE UNITED STATES, VERSION 8.2, USDA-NRCS, 2018 AND (FOR DISTURBED SITES) FIELD INDICATORS FOR IDENTIFYING HYDRIC SOILS IN NEW ENGLAND, VERSION 4. NEWIPCC WETLANDS WORK GROUP (2019).
 - C) NATIONAL LIST OF PLANT SPECIES THAT OCCUR IN WETLANDS: NORTHEAST (REGION 1). USFWS (MAY 1988).
 - D) CLASSIFICATION OF WETLANDS AND DEEPWATER HABITATS OF THE UNITED STATES. USFW MANUAL FWS/OBS-79/31 (1997).
 - E) "IDENTIFICATION AND DOCUMENTATION OF VERNAL POOLS IN NEW HAMPSHIRE" (1997). NEW HAMPSHIRE FISH AND GAME DEPARTMENT.
- 2) WETLAND FLAGS WERE FIELD LOCATED BY AMBIT ENGINEERING, INC.

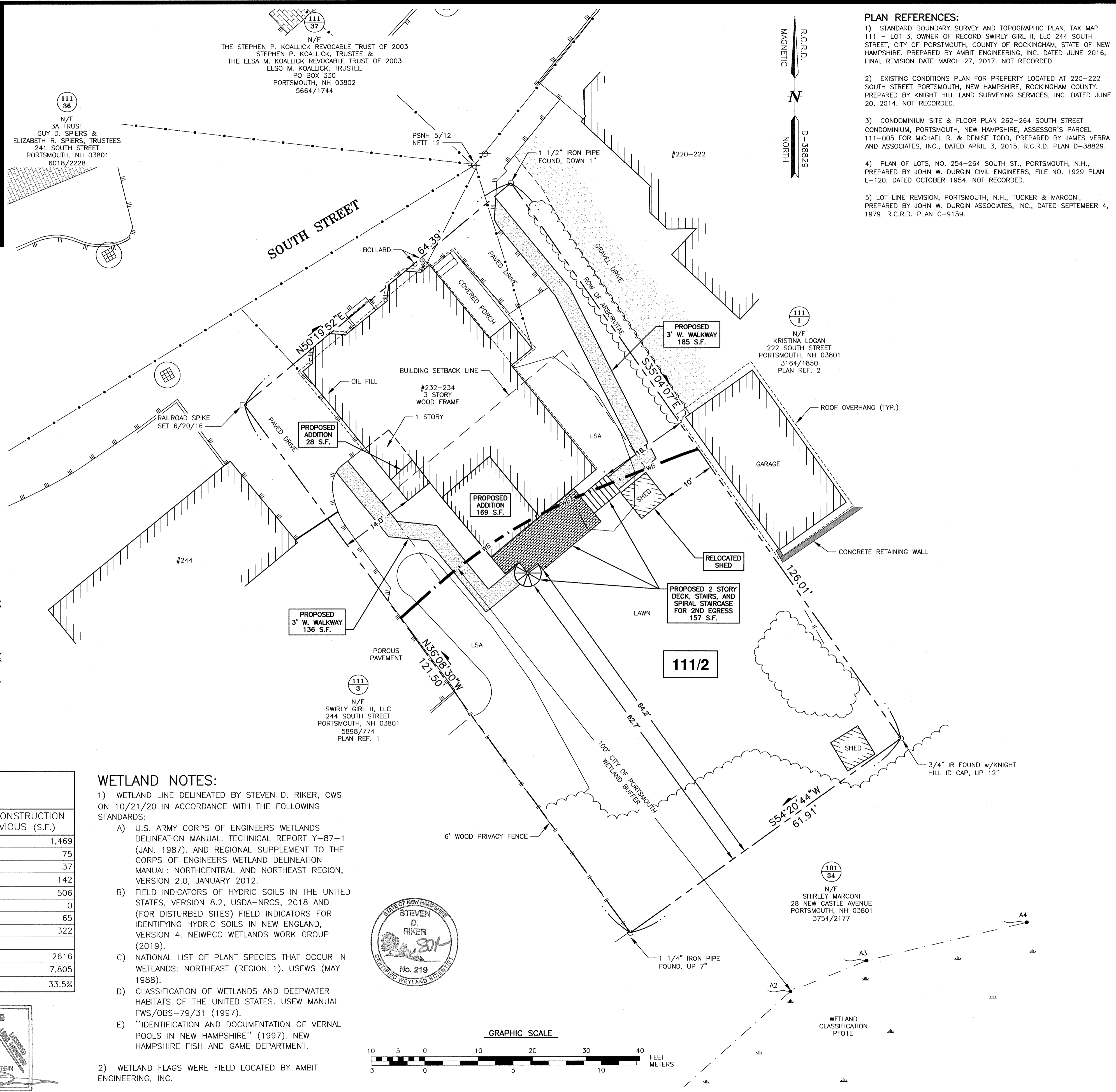
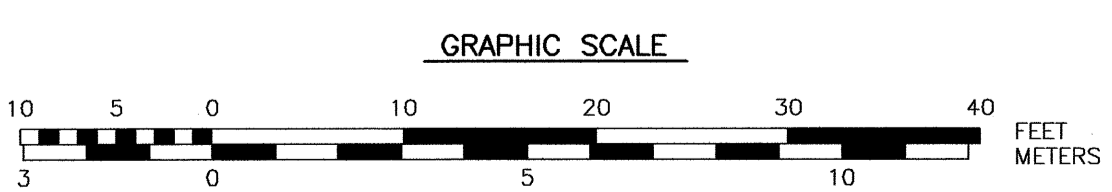
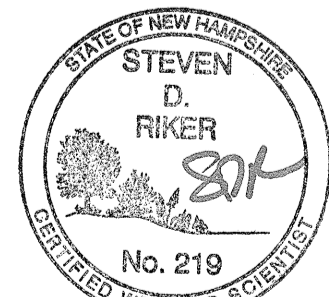

PLAN REFERENCES:

- 1) STANDARD BOUNDARY SURVEY AND TOPOGRAPHIC PLAN, TAX MAP 111 - LOT 3, OWNER OF RECORD SWIRLY GIRL II, LLC 244 SOUTH STREET, CITY OF PORTSMOUTH, COUNTY OF ROCKINGHAM, STATE OF NEW HAMPSHIRE. PREPARED BY AMBIT ENGINEERING, INC. DATED JUNE 2016, FINAL REVISION DATE MARCH 27, 2017. NOT RECORDED.
- 2) EXISTING CONDITIONS PLAN FOR PROPERTY LOCATED AT 220-222 SOUTH STREET PORTSMOUTH, NEW HAMPSHIRE, ROCKINGHAM COUNTY. PREPARED BY KNIGHT HILL LAND SURVEYING SERVICES, INC. DATED JUNE 20, 2014. NOT RECORDED.
- 3) CONDOMINIUM SITE & FLOOR PLAN 262-264 SOUTH STREET CONDOMINIUM, PORTSMOUTH, NEW HAMPSHIRE, ASSESSOR'S PARCEL 111-005 FOR MICHAEL R. & DENISE TODD, PREPARED BY JAMES VERRA AND ASSOCIATES, INC., DATED APRIL 3, 2015. R.C.R.D. PLAN D-38829.
- 4) PLAN OF LOTS, NO. 254-264 SOUTH ST., PORTSMOUTH, N.H., PREPARED BY JOHN W. DURGIN CIVIL ENGINEERS, FILE NO. 1929 PLAN L-120, DATED OCTOBER 1954. NOT RECORDED.
- 5) LOT LINE REVISION, PORTSMOUTH, N.H., TUCKER & MARCONI, PREPARED BY JOHN W. DURGIN ASSOCIATES, INC., DATED SEPTEMBER 4, 1979. R.C.R.D. PLAN C-9159.

AMBIT ENGINEERING, INC.
 Civil Engineers & Land Surveyors
 200 Griffin Road - Unit 3
 Portsmouth, N.H. 03801-7114
 Tel (603) 430-9282
 Fax (603) 436-2315

NOTES:

- 1) PARCEL IS SHOWN ON THE CITY OF PORTSMOUTH ASSESSOR'S MAP 111 AS LOT 2.
- 2) OWNER OF RECORD: JJCM REALTY LLC & TOP NOTCH PROPERTIES, LLC 9 PASTURE LANE BEDFORD, NH 03110 6198/478
- 3) PARCEL IS NOT IN A SPECIAL FLOOD HAZARD AREA AS SHOWN ON FIRM PANEL 33015C0259E. EFFECTIVE DATE MAY 17, 2005.
- 4) EXISTING LOT AREA: 7,805 S.F. 0.1792 ACRES
- 5) PARCEL IS LOCATED IN THE SINGLE RESIDENCE B (SRB) ZONING DISTRICT.
- 6) DIMENSIONAL REQUIREMENTS:

MIN. LOT AREA:	15,000 S.F.
FRONTAGE:	100 FEET
SETBACKS:	FRONT 30 FEET
	SIDE 10 FEET
	REAR 30 FEET
MAXIMUM STRUCTURE HEIGHT:	35 FEET
MAXIMUM BUILDING COVERAGE:	20%
MINIMUM OPEN SPACE:	40%
- 7) THE PURPOSE OF THIS PLAN IS TO SHOW THE PROPOSED ADDITION & OTHER APPURTENANT FEATURES ON ASSESSOR'S MAP 111 LOT 2 IN THE CITY OF PORTSMOUTH FOR REVIEW AND PERMITTING.
- 8) PROPOSED ADDITION AND OTHER BUILDING INFORMATION FROM PLANS BY DESTEFANO MAUGEL ARCHITECTS DATED OCTOBER 22, 2020.
- 9) BUILDING COVERAGE:

EXISTING:	1,518 S.F.
	1,518 S.F./7,805 = 19.4%
PROPOSED:	1,788 S.F.
	1,788 S.F./7,805 = 22.9%
PROPOSED OPEN SPACE:	74%

BUILDING ADDITION
JJCM REALTY, LLC &
TOP NOTCH PROPERTIES, LLC
232 SOUTH STREET
PORTSMOUTH, N.H.

NO.	DESCRIPTION	DATE
1	ISSUED FOR APPROVAL	12/22/20
0	ISSUED FOR COMMENT	12/11/20

REVISIONS		

SCALE 1"=10' OCTOBER 2020

BUILDING PERMIT APPLICATION PLAN **C1**

NOTES:

- UNDERGROUND UTILITY LOCATIONS ARE BASED UPON BEST AVAILABLE EVIDENCE AND ARE NOT FIELD VERIFIED. LOCATING AND PROTECTING ANY ABOVEGROUND OR UNDERGROUND UTILITIES IS THE SOLE RESPONSIBILITY OF THE CONTRACTOR AND/OR THE OWNER. UTILITY CONFLICTS SHOULD BE REPORTED AT ONCE TO THE DESIGN ENGINEER.
- THE CONTRACTOR SHALL NOTIFY DIG SAFE AT 1-888-DIG-SAFE (1-888-344-7233) AT LEAST 72 HOURS PRIOR TO COMMENCING ANY EXCAVATION ON PUBLIC OR PRIVATE PROPERTY.
- CONTRACTOR SHALL INSTALL AND MAINTAIN EROSION CONTROL MEASURES IN ACCORDANCE WITH THE "NEW HAMPSHIRE STORMWATER MANUAL, VOLUME 3, EROSION AND SEDIMENT CONTROLS DURING CONSTRUCTION. (NHDES DECEMBER 2008).
- PER CITY OF PORTSMOUTH ZONING ORDINANCE, ARTICLE 10.1018.24 FERTILIZERS: THE USE OF ANY FERTILIZER IS PROHIBITED IN A WETLAND, VEGETATED BUFFER STRIP OR LIMITED CUT AREA; AND THE USE OF FERTILIZERS OTHER THAN LOW PHOSPHATE AND SLOW RELEASE NITROGEN FERTILIZERS IS PROHIBITED IN ANY PART OF A WETLAND BUFFER.
- THE PURPOSE OF THIS PLAN IS TO SHOW THE CONSTRUCTION OF SOME BUILDING IMPROVEMENTS ON MAP 111, LOT 2.
- A PORTION OF THE LOT IS LOCATED WITHIN THE PREVIOUSLY DEVELOPED 100' CITY OF PORTSMOUTH WETLAND BUFFER.
- WETLAND LINE DELINEATED BY STEVEN D. RIKER, CWS ON 10/21/20 IN ACCORDANCE WITH THE FOLLOWING STANDARDS:
 - U.S. ARMY CORPS OF ENGINEERS WETLANDS DELINEATION MANUAL, TECHNICAL REPORT Y-87-1 (JAN. 1987), AND REGIONAL SUPPLEMENT TO THE CORPS OF ENGINEERS WETLAND DELINEATION MANUAL: NORTH-CENTRAL AND NORTHEAST REGION, VERSION 2.0, JANUARY 2012.
 - FIELD INDICATORS OF HYDRIC SOILS IN THE UNITED STATES, VERSION 8.2, USDA-NRCS, 2018 AND (FOR DISTURBED SITES) FIELD INDICATORS FOR IDENTIFYING HYDRIC SOILS IN NEW ENGLAND, VERSION 4. NEWPPCC WETLANDS WORK GROUP (2019).
 - NATIONAL LIST OF PLANT SPECIES THAT OCCUR IN WETLANDS: NORTHEAST (REGION 1). USFWS (MAY 1988).
 - CLASSIFICATION OF WETLANDS AND DEEPWATER HABITATS OF THE UNITED STATES. USFWS MANUAL FWS/OBS-79/31 (1997).
 - "IDENTIFICATION AND DOCUMENTATION OF VERNAL POOLS IN NEW HAMPSHIRE" (1997). NEW HAMPSHIRE FISH AND GAME DEPARTMENT.
 - WETLAND FLAGS WERE FIELD LOCATED BY AMBIT ENGINEERING, INC.

**BUILDING ADDITION
 JJCM REALTY, LLC &
 TOP NOTCH PROPERTIES, LLC
 232 SOUTH STREET
 PORTSMOUTH, N.H.**

NO.	DESCRIPTION	DATE
1	ISSUED FOR APPROVAL	12/22/20
0	ISSUED FOR COMMENT	12/10/20

REVISIONS

SCALE 1"=10' OCTOBER 2020

CUP PERMIT PLAN **C2**

LEGEND:

- N/F NOW OR FORMERLY
- RP RECORD OF PROBATE
- RCRD ROCKINGHAM COUNTY REGISTRY OF DEEDS
- MAP 11 / LOT 21
- BOUNDARY
- SETBACK
- RAILROAD SPIKE FOUND
- IRON ROD/PIPE FOUND
- DRILL HOLE FOUND
- STONE/CONCRETE BOUND FOUND
- RAILROAD SPIKE SET
- IRON ROD SET
- DRILL HOLE SET
- GRANITE BOUND SET
- EDGE OF PAVEMENT (EP)
- WOODS / TREE LINE
- UTILITY POLE (w/ GUY)
- METER (GAS, WATER, ELECTRIC)
- TYP. TYPICAL
- LSA LANDSCAPED AREA
- OVERHEAD ELECTRIC/WIRES
- CONTOUR
- PHOTO LOCATION

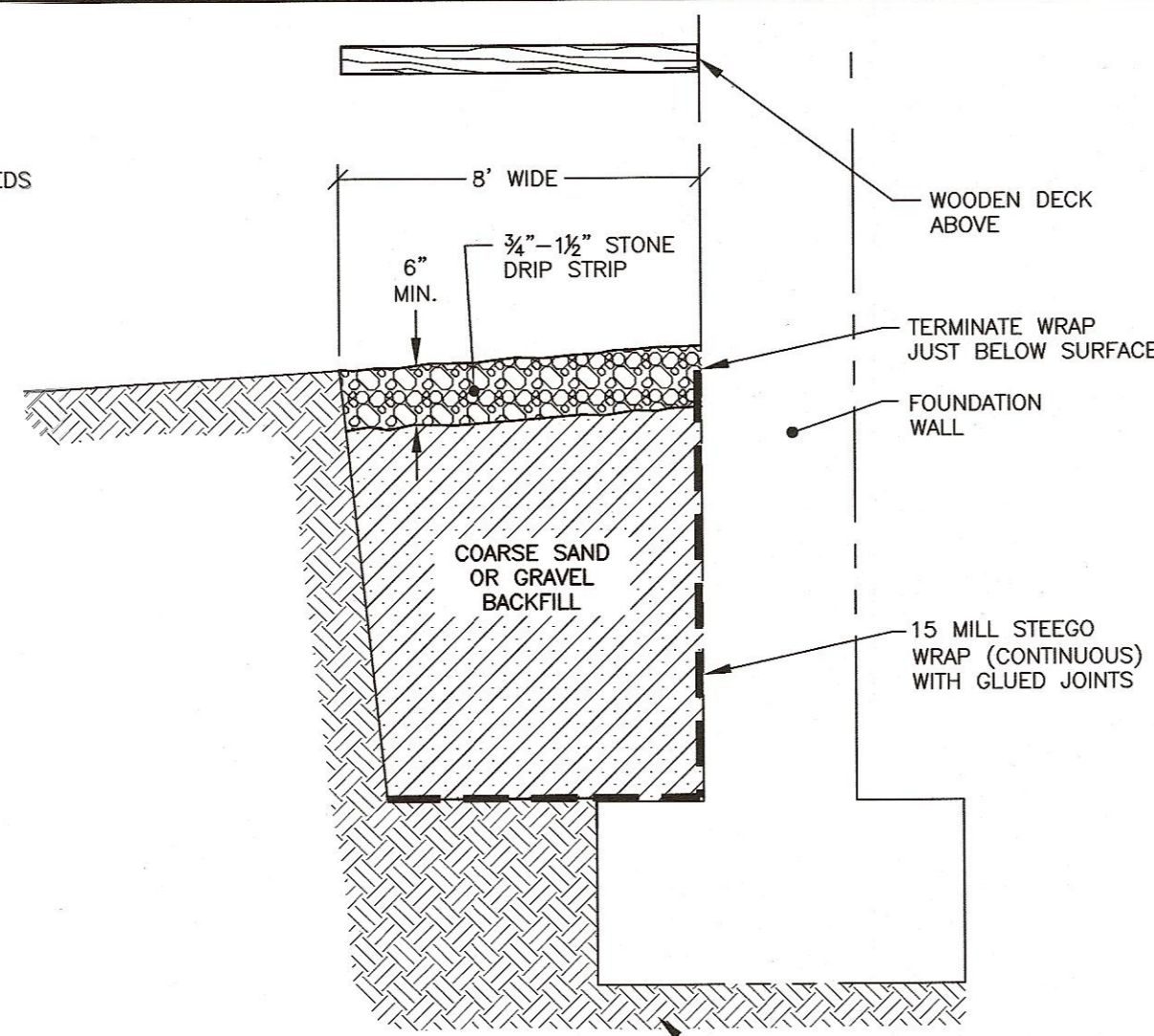

B C2 UNDER DECK STONE APRON
 NTS

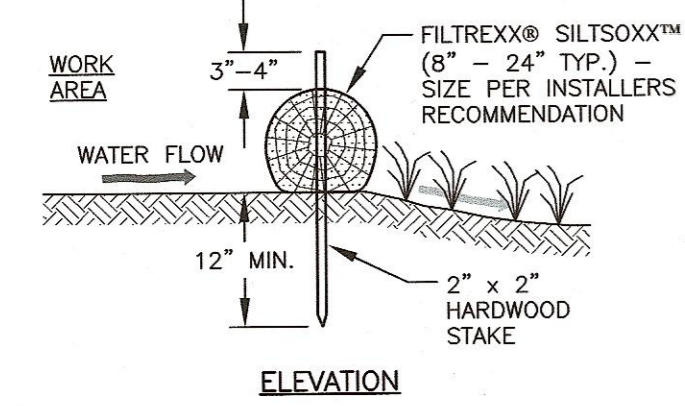
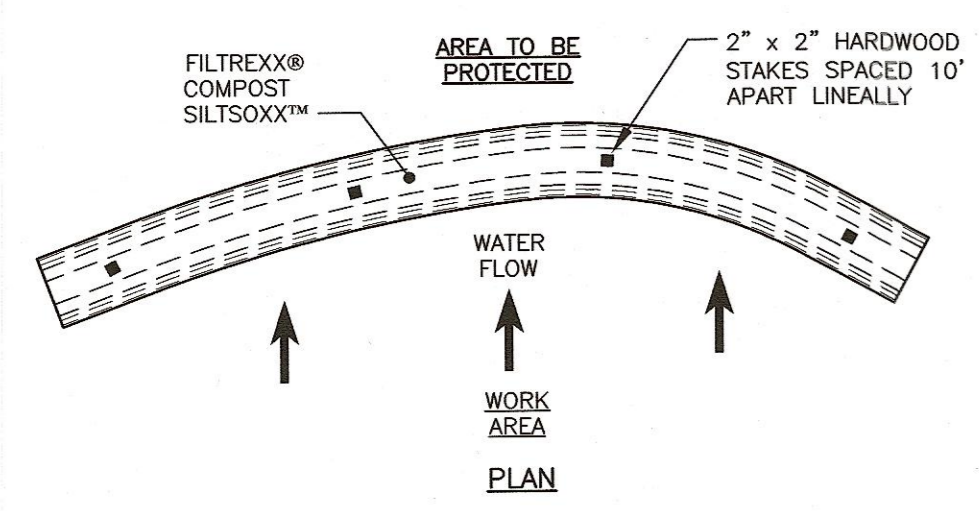

- NOTES:**
- ALL MATERIAL TO MEET FILTREXX SPECIFICATIONS.
 - FILTREXX SYSTEM SHALL BE INSTALLED BY A CERTIFIED FILTREXX INSTALLER.
 - THE CONTRACTOR SHALL MAINTAIN THE COMPOST FILTRATION SYSTEM IN A FUNCTIONAL CONDITION AT ALL TIMES. IT WILL BE ROUTINELY INSPECTED AND REPAIRED WHEN REQUIRED.
 - SILTSOXX DEPICTED IS FOR MINIMUM SLOPES, GREATER SLOPES MAY REQUIRE ADDITIONAL PLACEMENTS.
 - THE COMPOST FILTER MATERIAL WILL BE DISPERSED ON SITE WHEN NO LONGER REQUIRED, AS DETERMINED BY THE ENGINEER.

A C2 FILTREXX® SILTSOXX™ FILTRATION SYSTEM
 NTS

IMPERVIOUS SURFACE AREAS (TO PROPERTY LINE)		
STRUCTURE	PRE-CONSTRUCTION IMPERVIOUS (S.F.)	POST-CONSTRUCTION IMPERVIOUS (S.F.)
MAIN STRUCTURE	1,272	1,469
PORCHES	75	75
SHED	37	37
DECKS	66	142
PAVEMENT	506	506
PATIO	0	0
STAIRS	68	65
WALKWAYS	0	322
TOTAL	2024	2616
LOT SIZE	7,805	7,805
% LOT COVERAGE	25.9%	33.5%

BUFFER IMPACT AREAS			
ITEM	COLOR KEY	DECK AND ADDITION	SHED AND PLANTINGS
TEMPORARY IMPACT AREA	(Green)	364 S.F.	262 S.F.
PERMANENT IMPACT AREA	(Blue)	272 S.F.	N/A

CONSTRUCTION SEQUENCE

DO NOT BEGIN CONSTRUCTION UNTIL ALL LOCAL PERMITS HAVE BEEN APPLIED FOR AND RECEIVED.

INSTALL PERIMETER CONTROLS, I.E., SILTSOXX AROUND THE LIMITS OF DISTURBANCE BEFORE ANY EARTH MOVING OPERATIONS.

BEGIN CONSTRUCTION OF THE BUILDING FOUNDATION AND CONNECT TO EXISTING BUILDING. BEGIN BUILDING CONSTRUCTION.

PLANT LANDSCAPING IN AREAS OUT OF WAY OF BUILDING CONSTRUCTION. PREPARE AND STABILIZE FINAL SITE GRADING BY ADDING TOPSOIL, SEED AND MULCH.

AFTER BUILDINGS ARE COMPLETED, FINISH ALL REMAINING LANDSCAPED WORK.

REMOVE TRAPPED SEDIMENTS FROM COLLECTION DEVICES AS APPROPRIATE, AND THEN REMOVE TEMPORARY EROSION CONTROL MEASURES UPON COMPLETION OF FINAL STABILIZATION OF THE SITE.

BUFFER ENHANCEMENT AREA SCHEDULE:

BOTANICAL NAME / COMMON NAME	ROOT	SIZE	QTY.
CLETHRA ALNIFOLIA / SWEET PEPPERBUSH	CONT.	3-4 GAL.	4
MYRICA PENNSYLVANICA / BAYBERRY	CONT.	3-4 GAL.	4

*BUFFER AREA TO BE SEEDDED WITH SWITCHGRASS (PANICUM VERGATUM), TICKLESEED/ROUGH BENTGRASS (AGROSTIS SCABRA), VIRGINIA WILD RYE (ELYMUS VIRGINIUS) AND LITTLE BLUESTEM (SCHIZACHYRIUM SCOPARIUM) SPREAD THROUGHOUT.

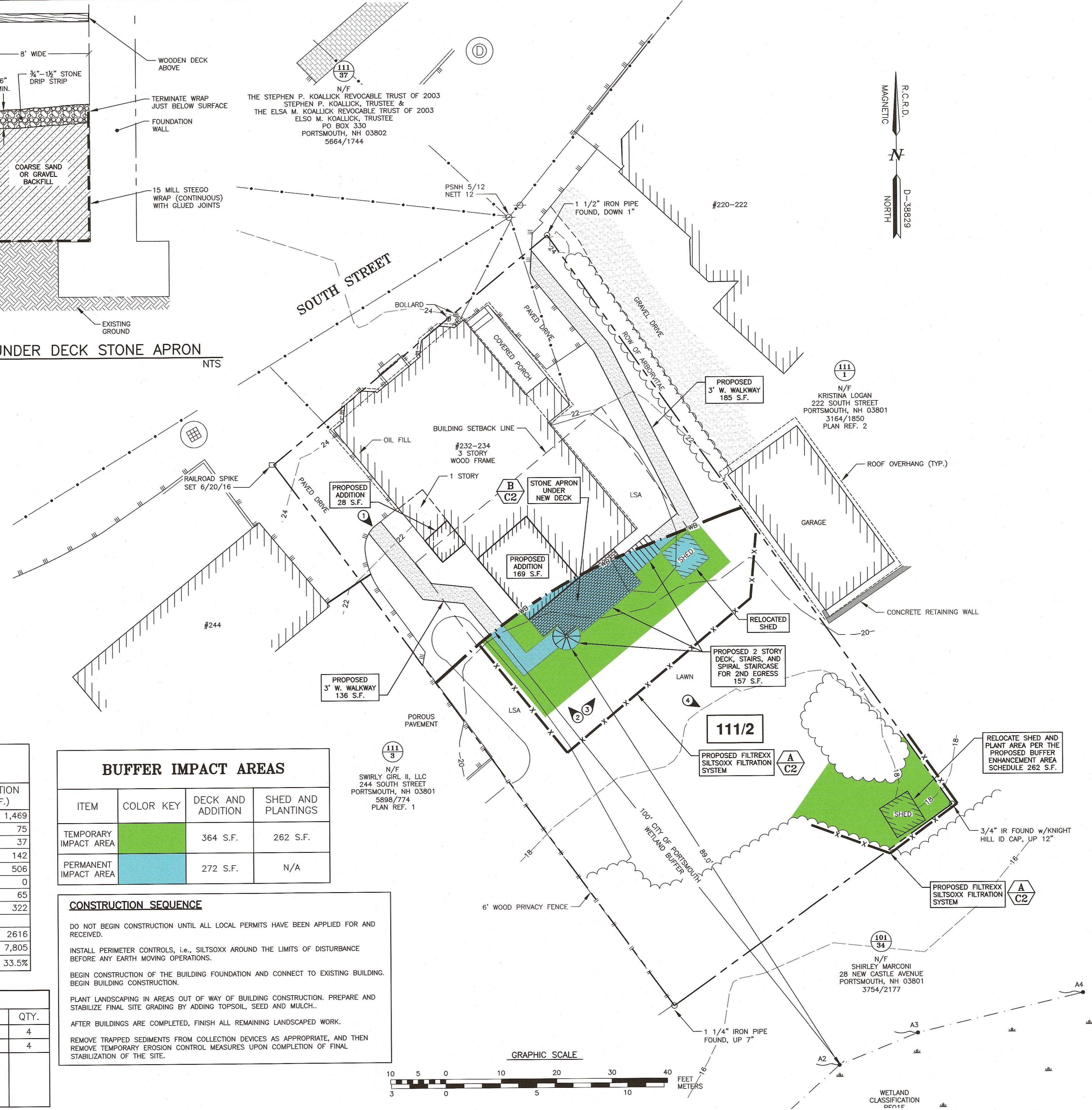
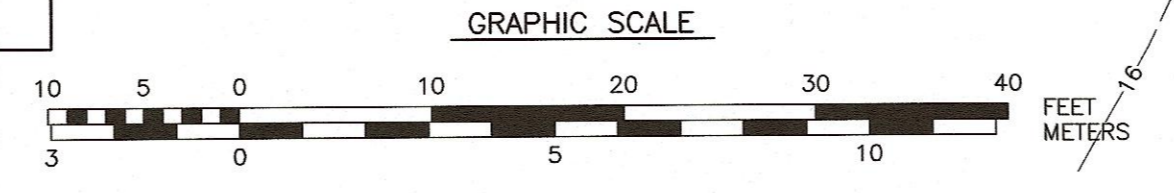

PERSPECTIVE VIEW



LOCUS PLAN

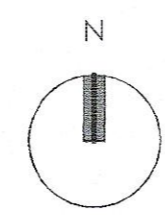
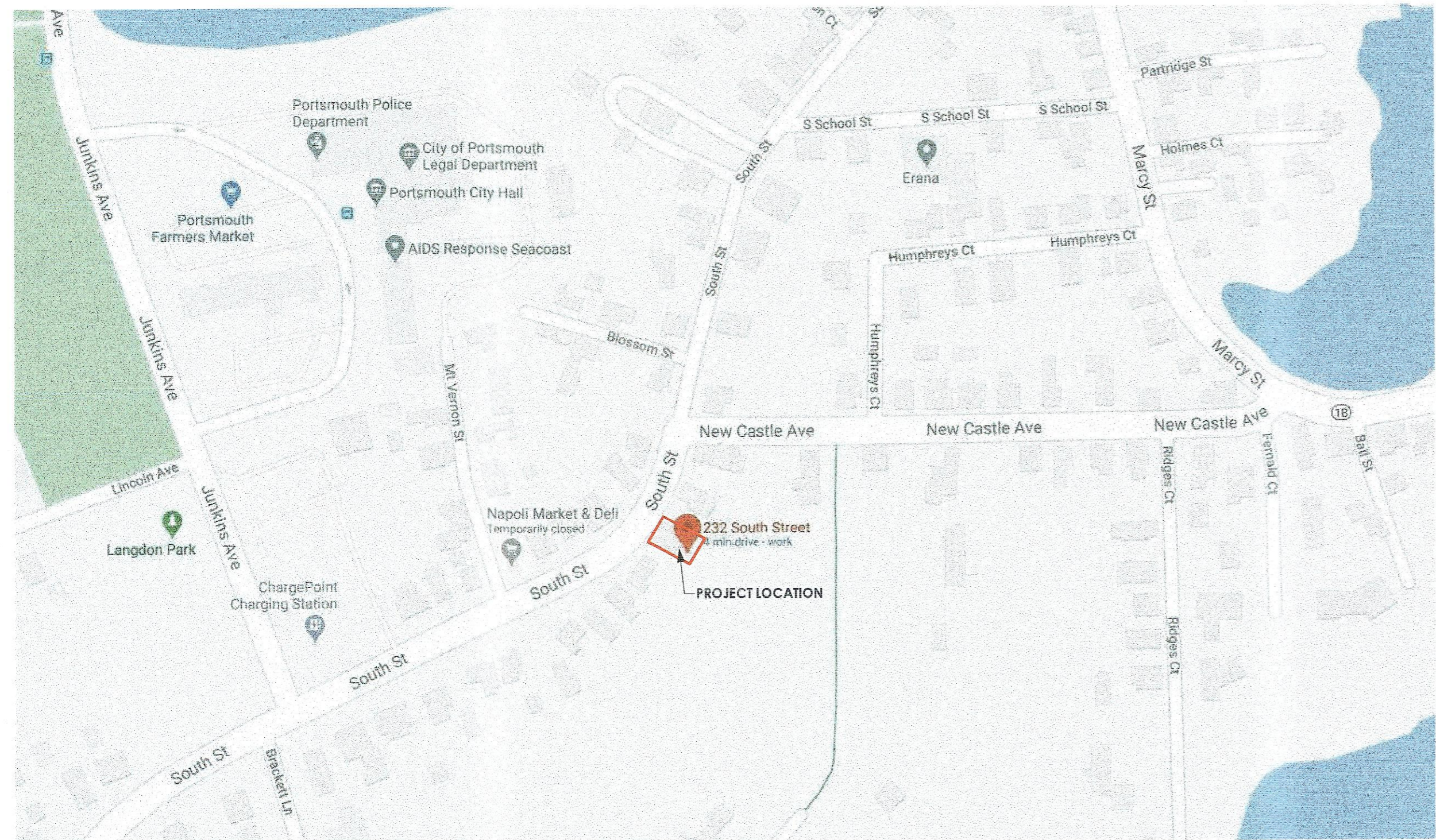

ARCHITECT: **D|M|A** DESTEFANO MAUGEL ARCHITECTS
 GENERAL CONTRACTOR: Matt Nagy
 STRUCTURAL ENGINEER: **SUMMIT ENGINEERING**

22 Ladd Street
 Portsmouth NH, 03801
 PH: 603.431.8701
 DeStefanoMaugel.com

603.512.9860
 matt.craftsmancarpentry@gmail.com

5 Greenleaf Woods Drive, #302
 Portsmouth NH, 03801
 PH: 603.319.1817
 summitengineeringinc.com

ARCHITECTURAL SYMBOLS

Room name	ROOM TAG
101	150 SF
101	DOOR TAG
1 A101	BUILDING ELEVATION
1 A101 SIM	WALL SECTION MARKER
1 A101 SIM	DETAIL MARKER
1 A101	WINDOW TAG
Name Elevation	ELEVATION HEIGHT MARKER
1 A101 SIM	CALLOUT MARKER
1 A101 SIM 1 A101 SIM	BUILDING SECTION MARKER
1 A1.1 #	INT. ELEVATION MARKER STEP
DN	STEP
L	LIMITING DEVICE
E	EGRESS WINDOW
T	TEMPERED GLASS

ARCHITECTURAL ABBREVIATIONS

ADJ	ADJUSTABLE
A.F.F.	ABOVE FINISH FLOOR
ALUM	ALUMINUM
ANSI	AMERICAN NATIONAL STANDARDS INSTITUTE
APPROX	APPROXIMATE
ARCH	ARCHITECT(URAL)
AUTO	AUTOMATIC
A/V B	AIR/VAPOR BARRIER
B	BOTTOM
B.O.	BOTTOM OF
BLDG	BUILDING
C	CENTERLINE
C.O.	CASED OPENING
CLG	CEILING
CLG. H.	CEILING HEIGHT
C.M.U.	CONCRETE MASONRY UNIT
CRS	MASONRY COURSE
DET	DETAIL
DF	DRINKING FOUNTAIN
DN	DOWN
DWGS	DRAWINGS
EA	EACH
EQ	EQUAL
EXT	EXTERIOR
FND	FOUNDATION
FP	FIREPLACE
FT	FEET
FTG	FOOTING
GRD	GRADE
GWB	GYPSUM WALL BOARD
H	HEIGHT/HIGH
H.C.	HOLLOW CORE
H.B.	HOSE BIB
HORZ	HORIZONTAL
H.P.	HIGH POINT
INSUL	INSULATION
L	LENGTH
MAX	MAXIMUM
MFR	MANUFACTURER
MIN	MINIMUM
MTL	METAL
N.I.C.	NOT IN CONTRACT
N.T.E.	NOT TO EXCEED
N.T.S.	NOT TO SCALE
O.C.	ON CENTER
O.F.O.I.	OWNER FURNISHED & OWNER INSTALLED
O.F.C.I.	OWNER FURNISHED & CONTRACTOR INSTALLED
O&M	OPERATION AND MAINTENANCE MANUAL
OPP	OPPOSITE
O.H.	OPPOSITE HAND
PTD	PAINTED
P.L.	PROPERTY LINE
R	RISER AT STAIR
REQ'D	REQUIRED
RM	ROOM
R.O.	ROUGH OPENING
R&S	ROD AND SHELF
SIM	SIMILAR
S.C.	SOLID CORE
SQ	SQUARE
SQFT	SQUARE FOOT/FEET
STRUCT	STRUCTURAL
TEMP	TEMPERED
T.B.D.	TO BE DETERMINED
T.M.E.	TO MATCH EXISTING
T.O.S.	TOP OF SLAB
T	TREAD AT STAIR
T.O.	TOP OF
TYP	TYPICAL
U.N.O.	UNLESS NOTED OTHERWISE
VERT	VERTICAL
V.I.F.	VERIFY IN FIELD
W.I.C.	WALK-IN CLOSET
W.R.B.	WEATHER RESISTANT BARRIER
W/	WITH
W/O	WITHOUT

DRAWING LIST

GENERAL	
A0.00	COVER SHEET
ARCHITECTURAL	
AD.01	CODE REVIEW
D1.00	DEMOLITION FLOOR PLANS
D1.01	DEMOLITION FLOOR PLANS
D2.00	DEMOLITION ELEVATIONS
D2.01	DEMOLITION ELEVATIONS
A1.00	FLOOR PLANS
A1.01	FLOOR PLANS
A2.00	BUILDING ELEVATIONS
A2.01	BUILDING ELEVATIONS
A3.00	BUILDING SECTIONS
A3.10	WALL SECTIONS AND DETAILS
A6.00	DOOR & WINDOW SCHEDULES

Revisions:

#	Description	Date

D|M|A
 DESTEFANO
 MAUGEL
 ARCHITECTS
 22 Ladd Street
 Portsmouth NH, 03801
 PH: 603.431.8701
 DeStefanoMaugel.com

ADDITION AND RENOVATION FOR
232 SOUTH STREET
 PORTSMOUTH, NH

Title:
 COVER SHEET

Scale: As indicated
 Drawn By: AM
 Checked By: BR
 Project No.: 202020
 Date: 10/16/2020

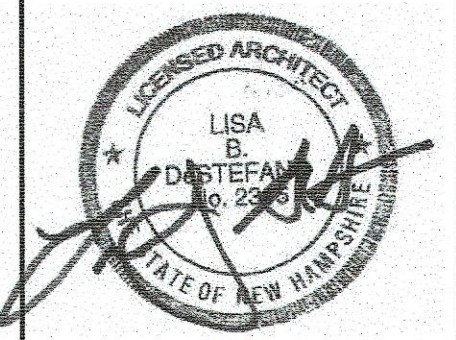

Reduced Size
 Not to Scale

A0.00

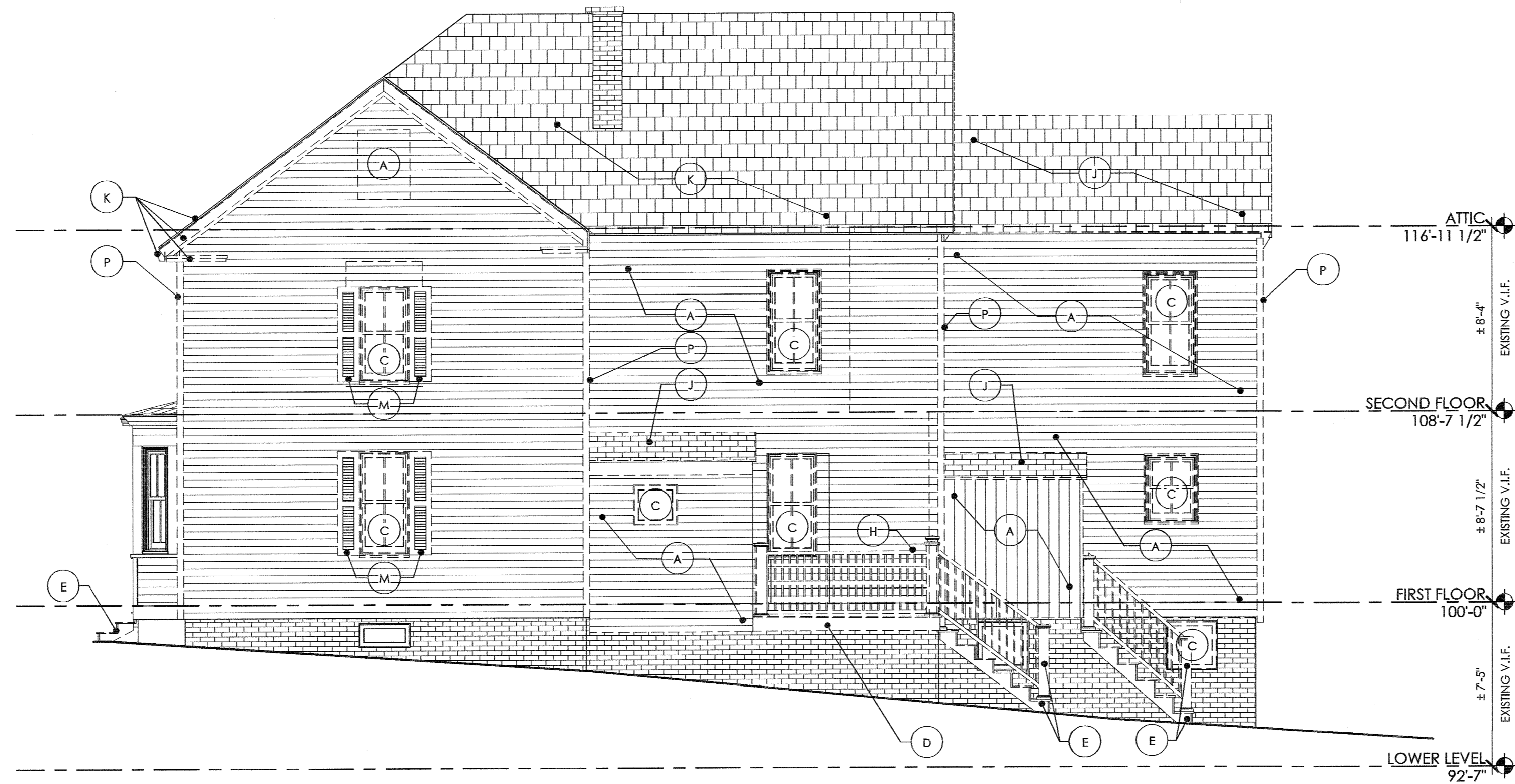

SOUTH DEMOLITION ELEVATION 2
1/4" = 1'-0"



EAST DEMOLITION ELEVATION 1
1/4" = 1'-0"

DEMOLITION NOTES

- ALL VINYL SIDING, VINYL TRIM, AND BREAK METAL TO BE REMOVED TO ALLOW FOR ARCHITECT REVIEW AND INSPECTION PRIOR TO ADDITIONAL SELECTIVE REMOVAL OF EXTERIOR FINISHES
- REFER TO CODE REVIEW OR SPECIFICATIONS FOR ALL OTHER DEMOLITION NOTES

DEMOLITION LEGEND

DASHED LINES DENOTE ELEMENTS TO BE REMOVED, UNLESS NOTED OTHERWISE.

DEMOLITION KEYNOTE LEGEND	
KEY	DESCRIPTION
A	WALL OR PORTION OF WALL TO BE REMOVED, TYPICAL. SEE PLANS AND ELEVATIONS.
C	WINDOW TO BE REMOVED, TYPICAL.
D	PORTION OF FLOOR, SUBSTRATE, INSULATION AND CEILING BELOW TO BE REMOVED. EXPOSED STRUCTURE TO REMAIN. SEE FLOOR PLAN FOR EXTENT.
E	STAIR AND ASSOCIATED RAILING TO BE REMOVED.
H	RAILING TO BE REMOVED IN ITS ENTIRETY.
J	ROOF TO BE REMOVED IN ITS ENTIRETY.
K	ROOF FASCIAS, AND ROOF SHINGLES TO BE REMOVED AND REPLACED. AT ALL ORIGINAL FRONT HOUSE LOCATIONS REMOVE BREAK METAL TRIM OR VINYL FOR DMA TO INSPECT EXISTING DETAILS AND DETERMINE REMOVAL OR REPLACEMENT OF THE ORIGINAL HISTORIC FASCIA BOARDS. TYPICAL.
M	SHUTTERS TO BE REMOVED.
P	CORNERBOARD TO BE REMOVED, TYPICAL.
S	ELECTRICAL METERS TO BE REMOVED AND REPLACED BY UTILITY COMPANY.

Revisions:
Description Date

DMA
DESTEFANO
MAUGEL
ARCHITECTS
22 Ladd Street
Portsmouth NH, 03801
PH: 603.431.8701
DestefanoMaugel.com

ADDITION AND RENOVATION FOR
232 SOUTH STREET
PORTSMOUTH, NH

Title:
DEMOLITION
ELEVATIONS

Scale: As indicated
Drawn By: AM
Checked By: BR
Project No.: 202020
Date: 10/16/2020

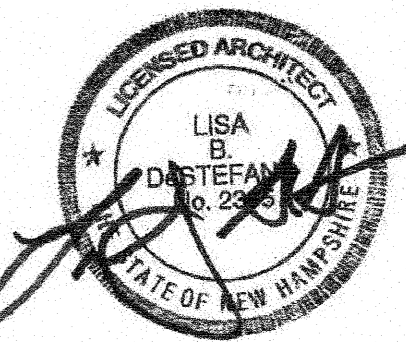

Reduced Size
Not to Scale

D2.00

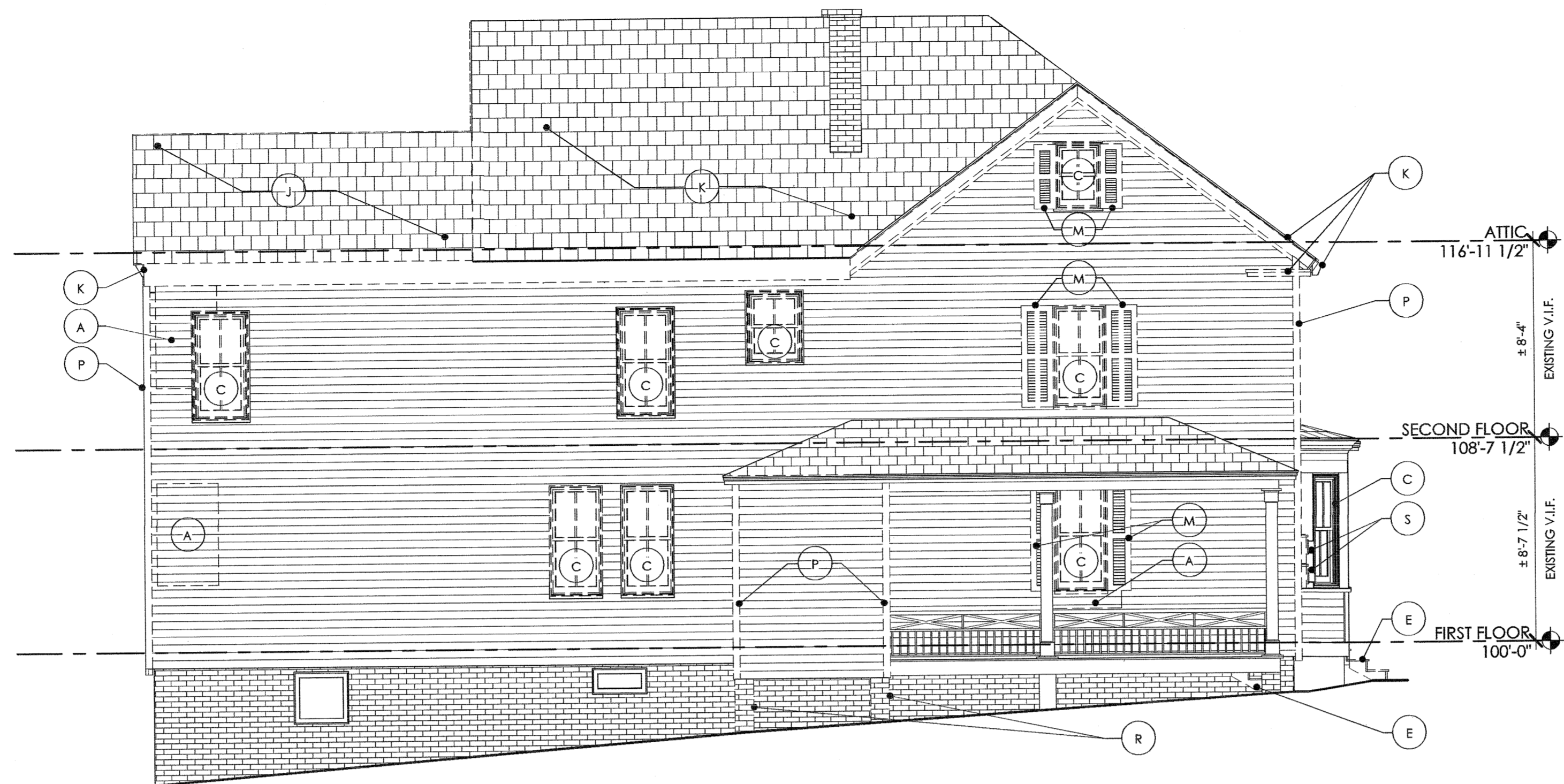

NORTH DEMOLITION ELEVATION 1
1/4" = 1'-0"

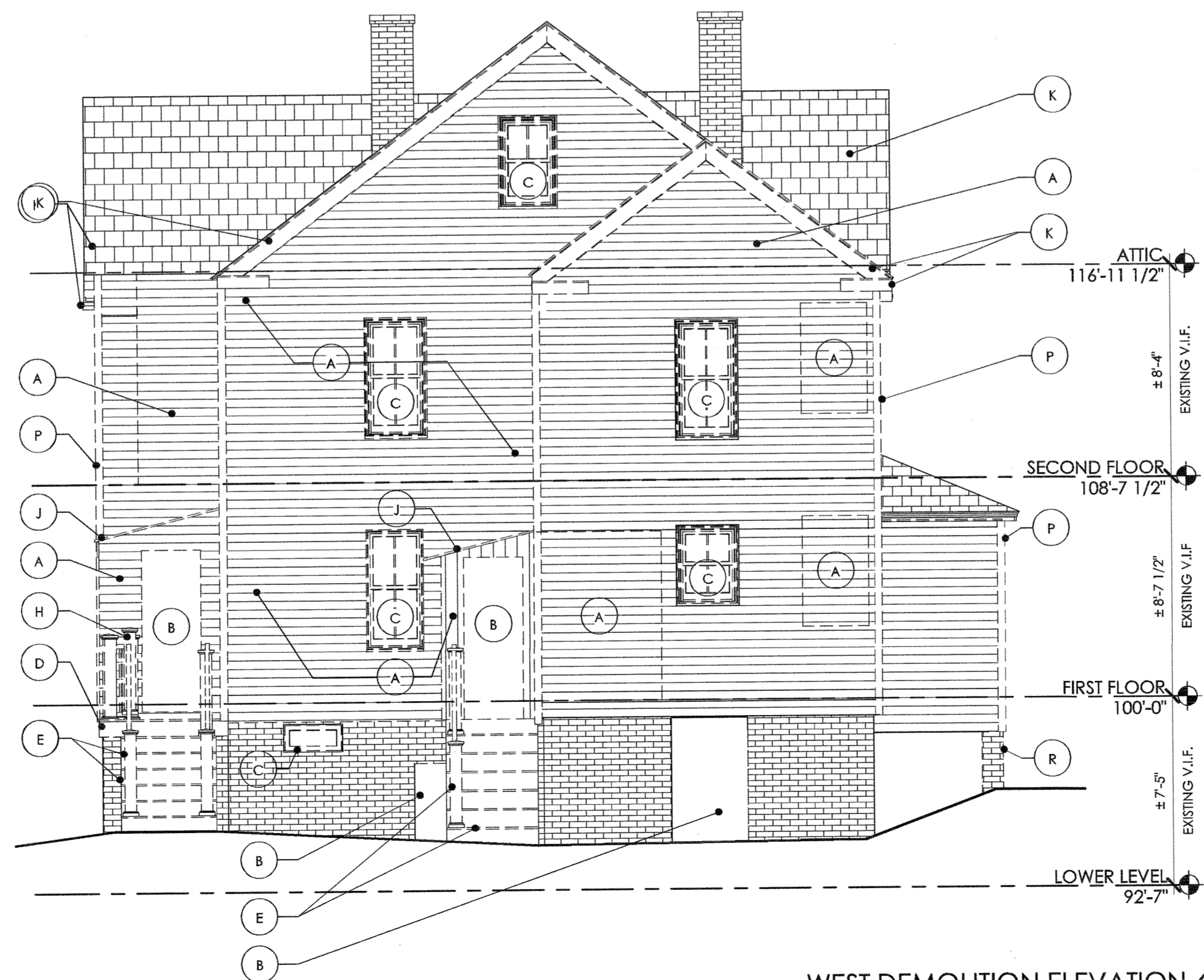

WEST DEMOLITION ELEVATION 2
1/4" = 1'-0"

DEMOLITION NOTES

- ALL VINYL SIDING, VINYL TRIM, AND BREAK METAL TO BE REMOVED TO ALLOW FOR ARCHITECT REVIEW AND INSPECTION PRIOR TO ADDITIONAL SELECTIVE REMOVAL OF EXTERIOR FINISHES
- REFER TO CODE REVIEW OR SPECIFICATIONS FOR ALL OTHER DEMOLITION NOTES

DEMOLITION LEGEND

DASHED LINES DENOTE ELEMENTS TO BE REMOVED, UNLESS NOTED OTHERWISE.

DEMOLITION KEYNOTE LEGEND

KEY	DESCRIPTION
A	WALL OR PORTION OF WALL TO BE REMOVED, TYPICAL. SEE PLANS AND ELEVATIONS.
B	DOOR TO BE REMOVED, TYPICAL.
C	WINDOW TO BE REMOVED, TYPICAL.
D	PORTION OF FLOOR, SUBSTRATE, INSULATION AND CEILING BELOW TO BE REMOVED. EXPOSED STRUCTURE TO REMAIN. SEE FLOOR PLAN FOR EXTENT.
E	STAIR AND ASSOCIATED RAILING TO BE REMOVED.
H	RAILING TO BE REMOVED IN ITS ENTIRETY.
J	ROOF TO BE REMOVED IN ITS ENTIRETY.
K	ROOF FASCIAS, AND ROOF SHINGLES TO BE REMOVED AND REPLACED, AT ALL ORIGINAL FRONT HOUSE LOCATIONS REMOVE BREAK METAL TRIM OR VINYL FOR DMA TO INSPECT EXISTING DETAILS AND DETERMINE REMOVAL OR REPLACEMENT OF THE ORIGINAL HISTORIC FASCIAS BOARDS. TYPICAL.
M	SHUTTERS TO BE REMOVED.
P	CORNERBOARD TO BE REMOVED, TYPICAL.
R	FOUNDATION WALL TO BE DEMOLISHED.
S	ELECTRICAL METERS TO BE REMOVED AND REPLACED BY UTILITY COMPANY.

Revisions:
Description Date

DMA
DESTEFANO
MAUGEL
ARCHITECTS
22 Ladd Street
Portsmouth NH, 03801
PH: 603.431.8701
DeStefanoMaugel.com

ADDITION AND RENOVATION FOR
232 SOUTH STREET
PORTSMOUTH, NH

Title:
DEMOLITION
ELEVATIONS

Scale: As indicated
Drawn By: AM
Checked By: BR
Project No.: 202020
Date: 10/16/2020

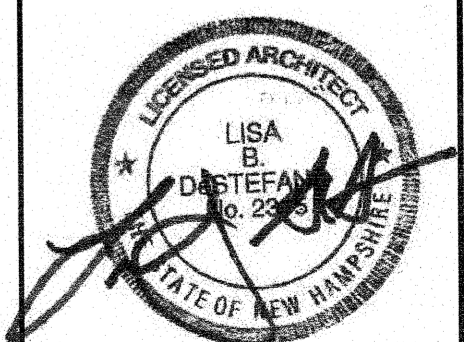

Reduced Size
Not to Scale

D2.01